

# TABLE OF CONTENTS

## GETTING STARTED

Accessories .....	1
Important safety instructions .....	2
Warnings, cautions and others .....	3
Disc information .....	4

## CONTROLS AND DISPLAYS

Remote control .....	5
Front panel connections .....	6
Display window .....	6
Rear panel connections .....	7

## CONNECTIONS

Connecting the antenna cable and television .....	8
For better video quality .....	9
S-Video out .....	9
Component out .....	9
For better audio quality .....	10
Connection to a stereo audio amplifier or receiver ...	10
Connection to a digital audio device .....	10
Digital out optical .....	10
Digital out coaxial .....	10
Connecting satellite receiver or cable box .....	11

## SYSTEM MENU

System menu .....	12
-------------------	----

## TV CHANNEL SETUP

TV channel search .....	13
Fine-tuning TV channels manually .....	13
Editing TV channels manually .....	13
Channel Editor .....	14

## SETTING UP G-Code® SYSTEM

Setting up G-Code® System .....	15
---------------------------------	----

## GUIDE

Playback .....	16
Record .....	17
Timer record .....	18
Copy .....	20

## RECORDING

Before recording .....	21
Recording television programs .....	21
Adding new recordings .....	22
Changing chapter intervals .....	22
Playing back the last recorded session .....	22
Recording from a VCR or Camcorder .....	23
One touch record .....	24
DV recording .....	24
DV control .....	26

## TIMER RECORDING

Setting the timer .....	26
Timer Record using the G-Code® system .....	27

## FLEX TIME

Pausing Live TV Broadcast .....	29
Record and Play .....	29

## PLAYBACK

Basic playback .....	30
POWER, OPEN/CLOSE, PLAY, F.F., REW. ....	30
NEXT, PREVIOUS .....	30
PAUSE/STEP, STOP, DISPLAY .....	30
DISC MENU, PLAYLIST .....	30
Navigation operation .....	31
REPEAT, ZOOM .....	31
SLOW, SEARCH .....	31
A-B REPEAT, SUBTITLE .....	31
AUDIO, ANGLE .....	31
INFORMATION .....	31
Playback video titles .....	32
Playback music files .....	33
Playback picture files .....	33
Audio CD playback .....	34
Playback pictures with music .....	34

## COPY

Copy from DVD to HDD .....	35
Copy from HDD to DVD .....	35

## EDIT

Browser menu .....	36
Naming a title .....	36
Protecting a title .....	36
Overwriting a title .....	36
Splitting a title .....	37
Merging titles .....	37
Erasing a title .....	37
Setting a title thumbnail .....	37
Chapter marks relevant setting .....	37

## DISK TOOLS

Erase .....	40
Finalize .....	40
Cleanup Disk .....	41
Defragment .....	41

## GUI OPERATION

## GLOSSARY

## SPECIFICATIONS

### Accessories

Please check and identify the supplied accessories.

- 1x Remote control   1x AV cable
- 2x Batteries 



# IMPORTANT SAFETY INSTRUCTIONS

- 1) **Read instructions.** Read all the safety and operating instructions before operating the product.
- 2) **Retain instructions.** Keep the safety and operating instructions for future reference.
- 3) **Heed warnings.** Adhere to all warnings on the product and in the operating instructions.
- 4) **Follow instructions.** Follow all operating and use instructions.
- 5) **Cleaning** - Unplug this product from the wall outlet before cleaning. Do not use liquid cleaners or aerosol cleaners. Use a damp cloth for cleaning.
- 6) **Attachments** - Do not use attachments not recommended by the product manufacturer as they may cause hazards.
- 7) **Water and Moisture** - Do not use this product near water for example, near a bathtub, washbowl, kitchen sink, or laundry tub, in a wet basement, or near a swimming pool.
- 8) **Accessories** - Do not place this product on an unstable cart, stand, tripod, bracket, or table. The product may fall, causing serious injury to a child or adult, and serious damage to the product. Use only with a cart, stand, tripod, bracket, or table recommended by the manufacturer or sold with the product. Any mounting of the product should follow the manufacturer's instructions and should use a mounting accessory recommended by the manufacturer.
- 9) **CART** - A product and cart combination should be moved with care. Quick stops, excessive force, and uneven surfaces may cause the product and cart combination to overturn.
- 10) **Ventilation** - Slots and openings in the cabinet provide ventilation, ensure reliable operation of the product, and protect it from overheating. Do not block or cover these openings. The openings should never be blocked by placing the product on a bed, sofa, rug, or other similar surface. Do not place this product in a built-in installation such as a bookcase or rack unless proper ventilation is provided or the manufacturer's instructions have been adhered to.
- 11) **Power Sources** - This product should be operated only from the type of power source indicated on the marking label. If you are not sure of the type of power supply to your home, consult your product dealer or local power company. For products intended to operate from battery power, or other sources, refer to the operating instructions.
- 12) **LOCATION** - The appliance should be installed in a stable location.
- 13) **NONUSE PERIODS** - The power cord of the appliance should be unplugged from the outlet when left unused for a long period of time.
- 14) **Grounding or Polarization** -
  - If this product is equipped with a polarized alternating current line plug (a plug having one blade wider than the other), it will fit into the outlet only one way. This is a safety feature. If you are unable to insert the plug fully into the outlet, try reversing the plug. If the plug should still fail to fit, contact your electrician to replace your obsolete outlet. Do not defeat the safety purpose of the polarized plug.
  - If this product is equipped with a three-wire grounding type plug, it will only fit into a grounding type power outlet. This is a safety feature. If you are unable to insert the plug into the outlet, contact your electrician to replace your obsolete outlet. Do not defeat the safety purpose of the grounding type plug.
- 15) **Power-Cord Protection** - Power-supply cords should be routed so that they are not likely to be walked on or pinched by items placed upon or against them, paying particular attention to cords at plugs, convenience receptacles, and the point where they exit from the product.
- 16) **Outdoor Antenna Grounding** - If an outside antenna or cable system is connected to the product, be sure the antenna or cable system is grounded so as to provide some protection against voltage surges and built-up static charges. Article 810 of the National Electrical Code, ANSI/NFPA 70, provides information with regard to proper grounding of the mast and supporting structure, grounding of the lead-in wire to an antenna discharge unit, size of grounding conductors, location of antenna-discharge unit, connection to grounding electrodes, and requirements for the grounding electrode.
- 17) **Lightning** - For added protection of this product during a lightning storm, or when it is left unattended and unused for long periods of time, unplug it from the wall outlet and disconnect the antenna or cable system. This will prevent damage to the product due to lightning and power-line surges.
- 18) **Power Lines** - An outside antenna system should not be located in the vicinity of overhead power lines or other electric lights or power circuits, or where it can fall into such power lines or circuits. When installing an outside antenna system, take extreme care to keep it from touching power lines or circuits. Contact with them might be fatal.
- 19) **Overloading** - Do not overload wall outlets, extension cords, or integral convenience receptacles. This can result in a risk of fire or electric shock.
- 20) **Objects and Liquids** - Do not push objects of any kind into this product through openings. They may touch dangerous voltage points or short out parts, resulting in a fire or electric shock. Liquids of any kind should not be used on or around this product.
- 21) **Servicing** - Do not attempt to service this product yourself. Opening or removing covers may expose you to dangerous voltage or other hazards. Refer all servicing to qualified service personnel.
- 22) **Damage Requiring Service** - Unplug this product from the wall outlet and refer servicing to qualified service personnel under the following conditions:
  - When the power supply cord or plug is damaged,
  - If liquid has spilled or objects have fallen into the product,
  - If the product has been exposed to rain or water,
  - If the product does not function properly after following the operating instructions, contact Customer Service for technical support.
  - If the product has been dropped or damaged in any way,
  - When the product exhibits a distinct change in performance. This indicates a need for service.
- 23) **Replacement Parts** - When replacement parts are required, be sure the service technician uses replacement parts specified by the manufacturer or having the same characteristics as the original part. Unauthorized substitutions may result in fire, electric shock, or other hazards.
- 24) **Safety Check** - Upon completion of any service or repairs to this product, ask the service technician to perform safety checks to determine that the product is in proper operating condition.
- 25) **Wall or Ceiling Mounting** - Mount the product to a wall or ceiling only as recommended by the manufacturer.
- 26) **Heat** - Keep this product away from heat sources, such as radiators, heat registers, stoves, or amplifiers.
- 27) **Battery Usage** - Battery leakage may result in bodily injury or damage to the unit. In order to avoid battery problems, please follow these instructions.
  - Install all batteries correctly, with + and - aligned as marked on the unit.
  - Do not mix batteries (old/new, carbon/alkaline, etc.).
  - Remove batteries when the unit is not used for a long time.

## WARNINGS, CAUTIONS AND OTHERS



**CAUTION**  
RISK OF ELECTRIC SHOCK  
DO NOT OPEN



### CAUTION!

TO REDUCE THE RISK OF ELECTRIC SHOCK,  
DO NOT REMOVE THE COVER OF THIS UNIT.  
THERE ARE NO USER SERVICEABLE PARTS INSIDE.  
REFER SERVICING TO QUALIFIED SERVICE PERSONNEL.



The lightning flash with arrowhead symbol, within an equilateral triangle, is intended to alert the user to the presence of uninsulated "dangerous voltage" within the product's enclosure that may be of sufficient magnitude to constitute a risk of electric shock to humans.



The exclamation point within an equilateral triangle is intended to alert the user to the presence of important operating and maintenance (servicing) instructions in the literature accompanying the appliance.

### CAUTION!

THIS PRODUCT UTILIZES A LASER.  
USE OF CONTROLS OR ADJUSTMENTS OR PERFORMANCE OF PROCEDURES OTHER THAN THOSE SPECIFIED HEREIN MAY RESULT IN HAZARDOUS RADIATION EXPOSURE. DO NOT OPEN THE COVER AND DO NOT REPAIR YOURSELF. REFER SERVICING TO QUALIFIED SERVICE PERSONNEL.

### WARNING:

TO REDUCE THE RISK OF FIRE, ELECTRIC SHOCK OR PRODUCT DAMAGE, DO NOT EXPOSE THIS APPARATUS TO MOISTURE AND ENSURE THAT OBJECTS FILLED WITH LIQUIDS, SUCH AS VASES, SHALL BE PLACED AWAY FROM THE APPARATUS.

### CAUTION! — POWER (⏻) button

Disconnect the main plug to shut the power off completely. The POWER (⏻) button in any position does not disconnect the main line. Power can be controlled from the remote.

### PRODUCTS WITH 525P PROGRESSIVE SCAN OUTPUTS NOTICE REQUIREMENTS

"CONSUMERS SHOULD NOTE THAT NOT ALL HIGH DEFINITION TELEVISION SETS ARE FULLY COMPATIBLE WITH THIS PRODUCT AND MAY CAUSE ARTIFACTS TO BE DISPLAYED IN THE PICTURE. IN CASE OF 525 PROGRESSIVE SCAN PICTURE PROBLEMS, IT IS RECOMMENDED THAT THE USER SWITCH THE CONNECTION TO THE "STANDARD DEFINITION" OUTPUT. IF THERE ARE QUESTIONS REGARDING OUR TV SET COMPATIBILITY WITH THIS MODEL 525P DVD PLAYER, PLEASE CONTACT OUR CUSTOMER SERVICE CENTER."

**G-CODE®**

G-CODE is a registered trademark of Gemstar Development Corporation.

The G-CODE system is manufactured under license from Gemstar Development Corporation.

### THE FOLLOWING APPLIES ONLY FOR U.S.A.

#### CAUTION!

This equipment has been tested and found to comply with the limits for a Class B digital device, pursuant to part 15 of the FCC Rules.

These limits are designed to provide reasonable protection against harmful interference in a residential installation. This equipment generates, uses and can radiate radio frequency energy and, if not installed and used in accordance with the instructions, may cause harmful interference to radio communications. However, there is no guarantee that interference will not occur in a particular installation. If this equipment does cause harmful interference to radio or television reception, which can be determined by turning the equipment off and on, the user is encouraged to try to correct the interference by one or more of the following measures:

- Reorient or relocate the receiving antenna.
- Increase the separation between the equipment and receiver.
- Connect the equipment into an outlet on a circuit different from that to which the receiver is connected.
- Consult the dealer or an experienced radio/TV technician for help.

#### IMPORTANT FOR LASER PRODUCTS

- 1)CLASS 1 LASER PRODUCT
- 2)**DANGER:** Visible and invisible laser radiation when open and interlock failed or defeated. Avoid direct exposure to beam.
- 3)**CAUTION:** Do not open the top cover. There are no user serviceable parts inside the Unit; leave all servicing to qualified service personnel.

#### CAUTION!

- CD-R/RW discs recorded using a personal computer or a CD Recorder may not play if the disc is damaged or dirty, or if there is dirt or condensation on the player's lens.
- Unfinalized CD-R/RW discs can be played, but not all time information (playing time, etc.) will be displayed.
- Check the copyright laws in your country before recording from DVD VIDEO, SVCD, Video CD, Audio CD, MP3 and JPEG discs. Recording of copyrighted material may infringe copyright laws.

#### Legal Notices Regarding Macrovision's Property Rights

"U.S. Patent Nos. 4,631,603; 4,577,216; 4,819,098; 4,907,093; and 6,516,132."

" This product incorporates copyright protection technology that is protected by U.S. patents and other intellectual property rights. Use of this copyright protection technology must be authorized by Macrovision, and is intended for home and other limited viewing uses only unless otherwise authorized by Macrovision. Reverse engineering or disassembly is prohibited. "

Manufactured under license from Dolby Laboratories.  
"Dolby" and the double-D symbol are trademarks of Dolby Laboratories.

# DISC INFORMATION

## ■ Playable Disc types

Disc Types	Logos	Characteristics
DVD-VIDEO		This unit can playback DVD-Video discs and the region code is printed on the rear of the unit.
DVD - R/RW DVD + R/RW		DVD - R, DVD - RW and DVD + R, DVD + RW, discs written in the DVD-Video format and finalized.
Video CD (VCD) Super Video CD (SVCD)		Video with CD sound, VHS quality & MPEG-1 compression technology.
Audio CD		CD is recorded as a Digital Signal with better audio quality, less distortion and less deterioration of audio quality over time.
CD-R/RW (JPEG/BMP/MP3)		This unit can play CD-R and CD-RW discs recorded with Audio CD or Video CD format, or with JPEG/BMP/MP3 files. Close the sessions or finalize the disc after recording.

## ■ Recordable Disc types

Disc Types	Logos	Characteristics
DVD +R/RW		DVD +R disc written in the DVD +VR format. DVD +RW disc written in the DVD + VR format.

### Notes:

The DVD-Video/DVD+RW/DVD+R/ Logos are trademarks of the respective companies.

For best results, use discs with the above logos. The unit may not playback other discs correctly. Do not use irregular-shaped discs (e.g. heart-shaped), as these can damage the unit.

It may not be possible to play CD-R, CD-RW, DVD-R, DVD-RW, DVD+R, DVD+RW in all cases due to the type of disc or condition of the recording.

### Unplayable disc types

The unit does not playback disc type listed below. If you try to play back these discs, excessive noise may cause damage to your speakers.

- 1) Unfinalized discs from other DVD recorders.
  - 2) DVD-VR, DVD AUDIO, PHOTO CD, SACD
- (When placing an unplayable disc on the disc tray, the DVD recorder will display "Unknown Disc" on the display panel after attempts of trying to loading the disc fail.)

### ■ Region code of DVD-Video

This unit can playback DVD-VIDEO discs compatible with the region code printed on the rear of the unit.

Example of playable DVD-VIDEO disks:



### ■ Audio System

Linear PCM

DTS (Digital Theater Systems)

### ■ Video System (PAL)

This DVD recorder accepts PAL signal input.

### ■ Aspect Ratio

4:3 (Letter Box) Standard

4:3 Pan & Scan

16:9 (Wide-Screen)

### ■ Others

Audio : Appears at the beginning of a scene recorded with multiple audio languages.

Subtitle : Appears at the beginning of a scene recorded with multiple subtitle languages.

Angle : Appears at the beginning of a scene recorded from multiple angles.



# CONTROLS AND DISPLAYS

## Remote Control

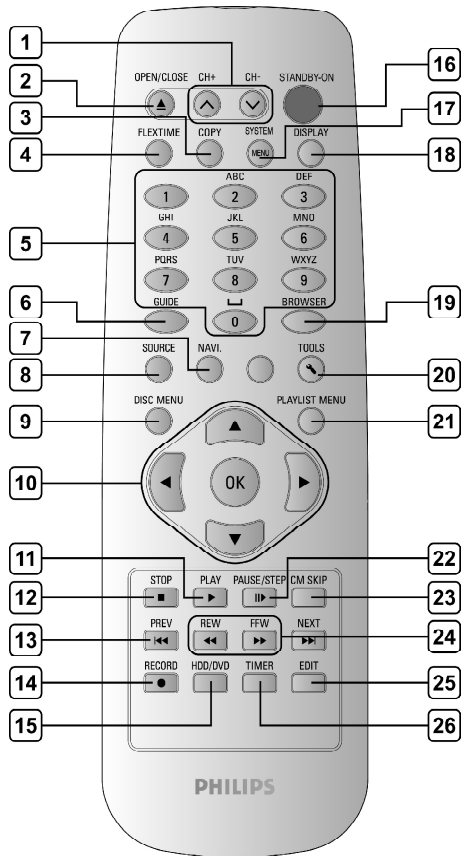

- 1) CH+, CH- buttons (▲, ▼)
- 2) Open/Close button (▲ OPEN/CLOSE)
- 3) Copy button (COPY)
- 4) Flex Timer button (FLEX TIME)
- 5) Numeric buttons (0, 1~9)
- 6) Guide button (GUIDE)
- 7) Navigation button (NAVI)
- 8) Source button (SOURCE)
- 9) Disc menu button (DISC MENU)
- 10) Cursor (▲▼◀▶), OK buttons (OK)
- 11) Play button (▶ PLAY)
- 12) Stop button (■ STOP)
- 13) Skip buttons (◀◀ PREVIOUS/▶▶ NEXT)
- 14) Record button (RECORD)
- 15) HDD/DVD button (HDD/DVD)
- 16) POWER ON/STANDBY button (STANDBY-ON)
- 17) System Menu button (SYSTEM MENU)
- 18) Display button (DISPLAY)
- 19) Browser (BROWSER)
- 20) G-Code button (G-Code)
- 21) Disk Tools button (TOOLS)
- 22) Playlist/Menu button (PLAYLIST / MENU)
- 23) Pause/Step button (||▶ PAUSE/STEP)
- 24) CM Skip button (CM Skip)
- 25) F.F./REW. buttons (◀◀ REW./▶▶ F.F)
- 26) Edit button (EDIT)
- 27) Timer button (TIMER)

### To install batteries

- Open the battery compartment and insert the batteries. Make sure the polarities (+ and -) match the marks indicated inside the remote control.

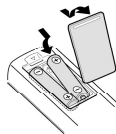

### CAUTION!

- Remove batteries if they are exhausted or if the Remote Control will not be used for a long time
- Do not use old and new or different types of batteries in combination
- Batteries contain chemical substances, so they should be disposed properly.

### Remote sensor

The remote has a range of approximately 3m and works best when pointed directly at the unit horizontally at angles up to 30° from the front of the unit.

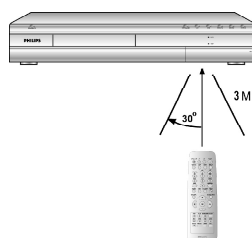

## CONTROLS AND DISPLAYS

### Front panel connections

(for reference only)

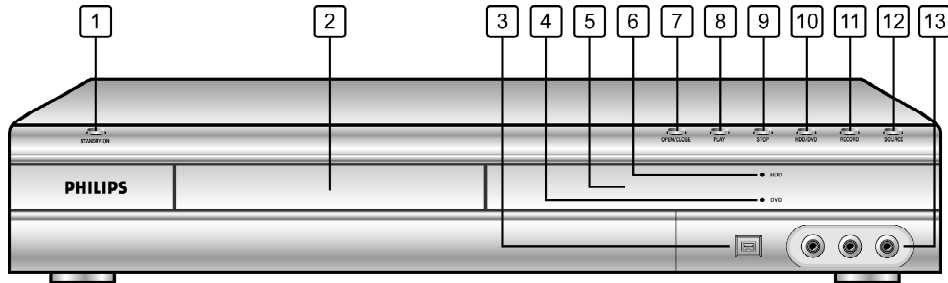

### Names of parts and controls

- |  |   |
|--|---|
| <ol style="list-style-type: none"> <li>1) <b>POWER ON/OFF Button</b><br/>Turns the recorder on and off.</li> <li>2) <b>DISC TRAY</b><br/>Holds discs securely during recording or playback</li> <li>3) <b>DV-LINK (IEEE-1394) Jack</b><br/>Connects digital video camcorders to this DVD Recorder.</li> <li>4) <b>DVD Indicator</b><br/>Lights up when DVD is set as the target device.</li> <li>5) <b>DISPLAY Panel</b><br/>Operation indicators are displayed here.</li> <li>6) <b>HDD Indicator</b><br/>Lights up when HDD is set as the target device</li> </ol> | <ol style="list-style-type: none"> <li>7) <b>OPEN/CLOSE Button</b><br/>Opens or closes the disk tray.</li> <li>8) <b>PLAY Button</b><br/>Plays a disk.</li> <li>9) <b>STOP Button</b><br/>Stops playing or recording a disk.</li> <li>10) <b>HDD/DVD Button</b><br/>Press to switch between HDD and DVD.</li> <li>11) <b>RECORD Button</b><br/>Starts recording.</li> <li>12) <b>SOURCE Button</b><br/>Select equipment connected to the line inputs.</li> <li>13) <b>FRONT AV (VIDEO/AUDIO L/R) Jacks</b><br/>Connects the input of external equipment.</li> </ol> |
|--|---|

### Display window

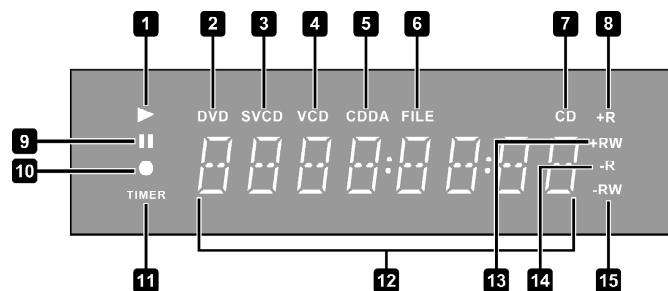

- |   |  |
|---|--|
| <ol style="list-style-type: none"> <li>1) <b>Play indicator</b></li> <li>2) <b>DVD indicator</b></li> <li>3) <b>SVCD indicator</b></li> <li>4) <b>VCD indicator</b></li> <li>5) <b>CDDA indicator</b></li> <li>6) <b>FILE indicator</b></li> <li>7) <b>CD indicator</b></li> <li>8) <b>DVD+R indicator</b></li> </ol> | <ol style="list-style-type: none"> <li>9) <b>Pause indicator</b></li> <li>10) <b>Record indicator</b></li> <li>11) <b>Timer record mode</b></li> <li>12) <b>Multi-information window</b></li> <li>13) <b>DVD+RW indicator</b></li> <li>14) <b>CD-R/DVD-R indicator</b></li> <li>15) <b>CD-RW/DVD-RW indicator</b></li> </ol> |
|---|--|

## CONTROLS AND DISPLAYS

### Rear panel connections (for reference only)

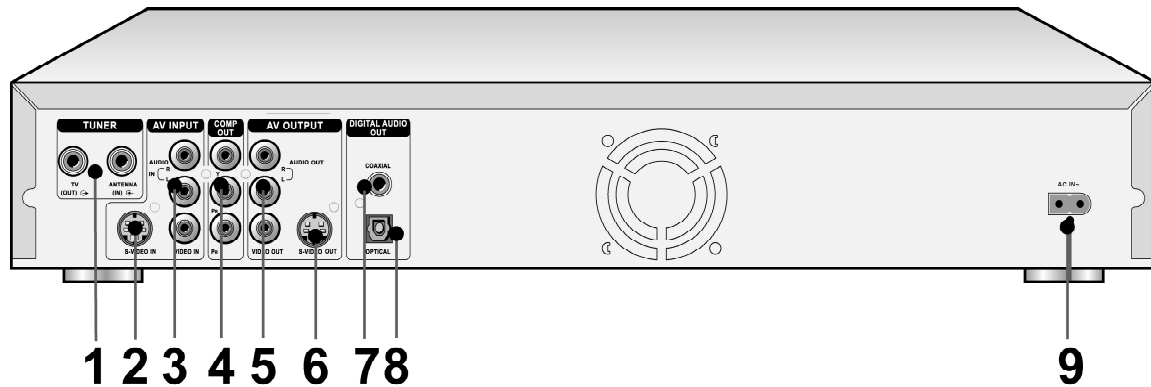

#### Names of parts

1) **TUNER(TV/ANTENNA) Jacks**

Connects TV/ANTENNA for signal output/input.

**Note:**

Playback signals don't go through here. Make proper connections before using this DVD Recorder.

2) **LINE IN (S-VIDEO) Jack**

S-Video signal input.

3) **AV2 Rear (VIDEO/AUDIO L/R) Jacks**

Composite signal input.

4) **COMPONENT VIDEO OUTPUT (Y/Pb/Pr) Jacks**

Component signal output.

5) **LINE OUT (VIDEO/AUDIO L/R) Jacks**

Composite signal output.

6) **LINE OUT (S-VIDEO) Jack**

S-Video signal output.

7) **DIGITAL AUDIO OUT (COAXIAL) Jack**

Connects an amplifier or receiver having a digital input jack.

8) **DIGITAL AUDIO OUT (OPTICAL) Jack**

Connects an amplifier or receiver having a digital input jack.

9) **AC In Terminal**

# CONNECTIONS

## Before making connections

- 1) Do not plug the AC power cord into the outlet until all other connections are made.
- 2) Connect VIDEO OUT of the unit directly to the video input of your TV. Connecting VIDEO OUT of the unit to a TV via a VCR may cause a viewing problem when playing back a copy-protected disk. You may also have a viewing problem when connecting the unit to an integrated TV/Video system.

## Connecting to the antenna outlet and the television

Before using the unit, follow the steps below to connect the unit to the antenna cable and TV.

### Connecting to a TV with COMPOSITE jacks

Use a RF cable (supplied) to connect the **ANTENNA IN** on the unit to the antenna outlet.

Use a RF cable (same as supplied) to connect the **TV OUT** on the unit to the RF input on the television.

Use AUDIO/VIDEO cables (supplied) to connect the **AUDIO/VIDEO output** on the unit to the audio/video input on the television.

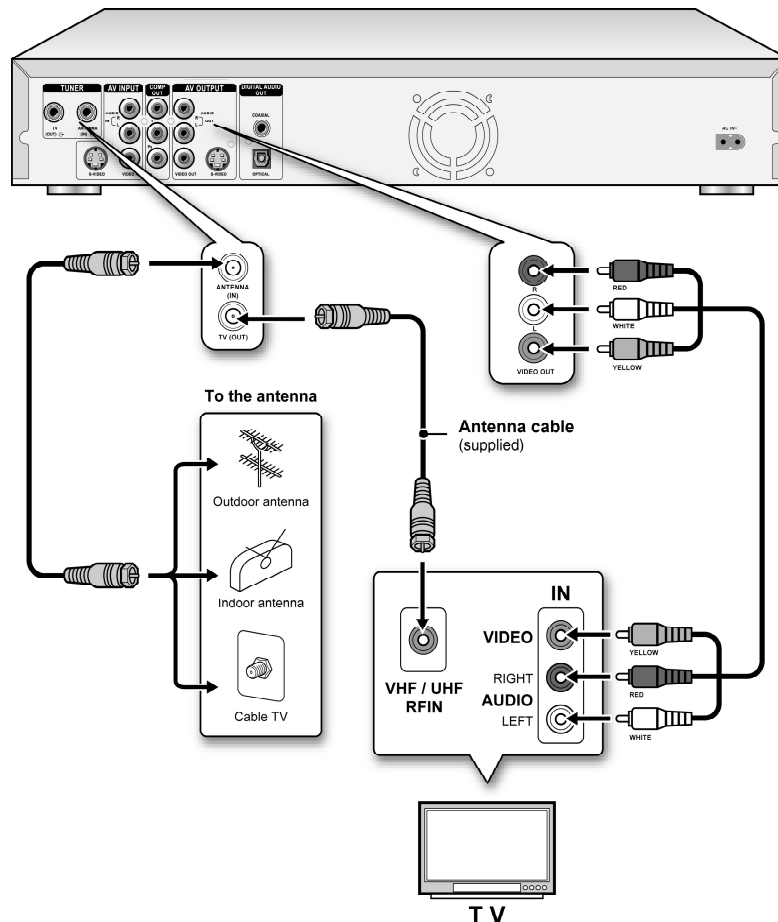

### Notes:

1. Do not place this unit on top of other equipment that may generate heat. Excessive heat may cause this unit to malfunction.
2. For Digital Cable and Satellite TV users please connect your decoder's output to this unit's input.

## FOR BETTER VIDEO QUALITY

There are two types of connections (**S-Video**, and **Component video**) that provide higher quality viewing.

### 1. Connecting to a TV via S-Video out

#### Connecting to a TV with a S-Video jack

Use a S-Video cable (not supplied) to connect the **S-Video output** on the unit to the S-Video input on the television.

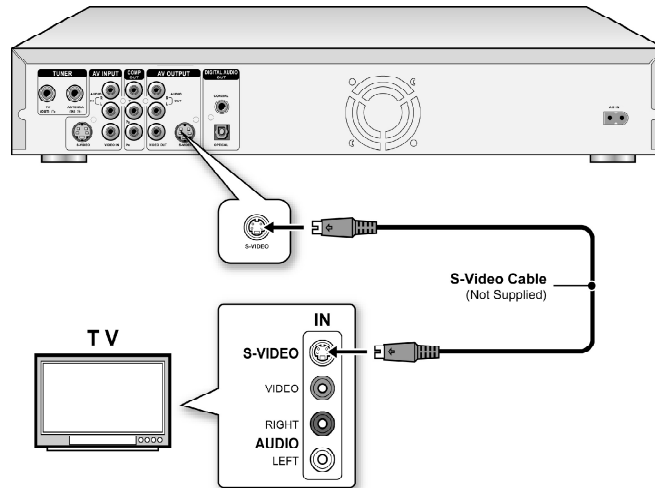

#### Notes:

1. Enter system setup to enable S-Video (refer to the section titled "Quick Setup").
2. When using S-Video connections, please remove all other video output connections.  
In this configuration, the Red and White audio cable connections are required (refer to the section titled "For better Audio Quality").

### 2. Connecting to a TV via COMPONENT out

#### Connecting to a TV with component jacks

Use COMPONENT cables (not supplied) to connect the **COMPONENT output** on the unit to the COMPONENT input on the television.

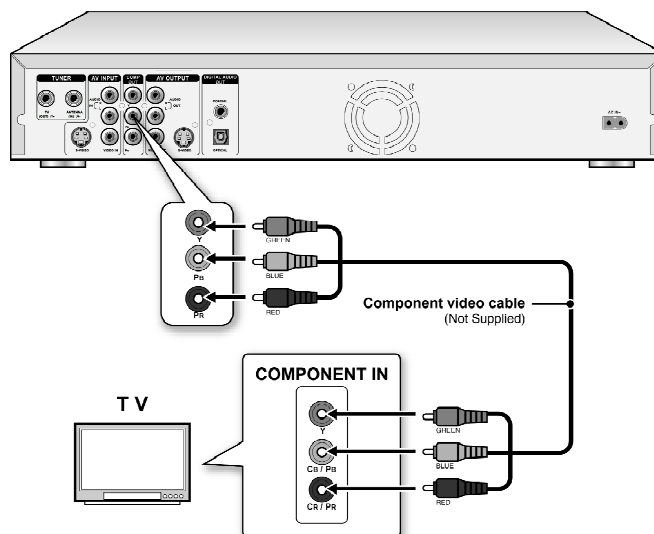

#### Notes:

1. Enter system setup to enable COMPONENT (refer to the section titled "Quick Setup").
2. When using COMPONENT connections, please remove all other video output connections.
3. In this configuration, the Red and White audio cable connections are required (refer to the section titled "For better Audio Quality").

# FOR BETTER AUDIO QUALITY

There are two types of audio connections, analog and digital.

## Connecting to a stereo audio amplifier or receiver

Use an audio cord to connect the **AUDIO OUT** on the unit to the audio input on a stereo amplifier or a receiver.

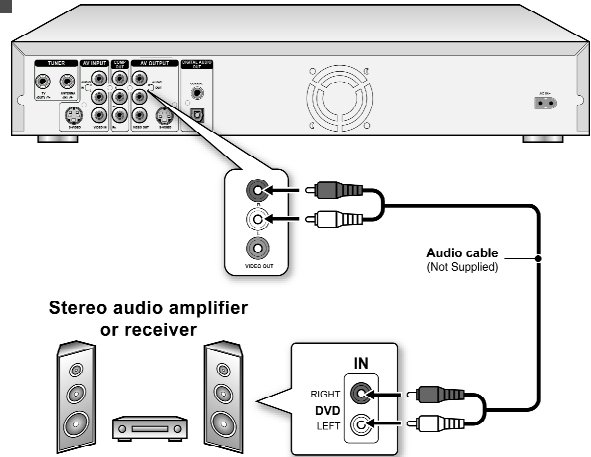

## Connecting to a digital audio device

Connect an amplifier with Dolby Digital and DTS decoders to enjoy surround sound.

### Digital out optical

Use a fiber-optic cable (not supplied) to connect the **DIGITAL OUT OPTICAL** (digital optical output) on the unit to the digital optical input on an stereo amplifier or a receiver.

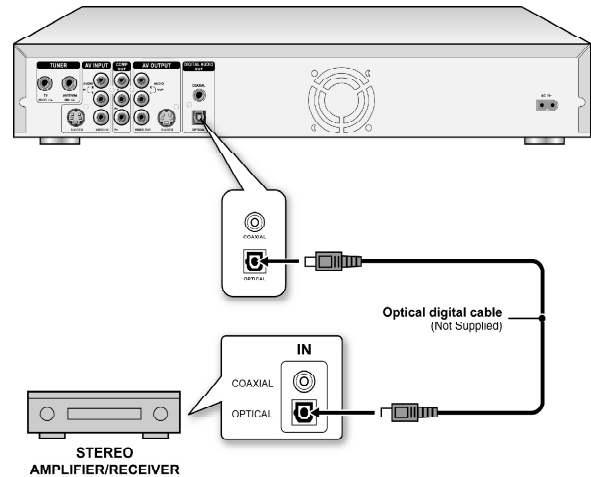

### Digital out coaxial

Use a coaxial cable (not supplied) to connect the **DIGITAL OUT COAXIAL** (coaxial digital output) on the unit to the coaxial digital input on an stereo amplifier or a receiver.

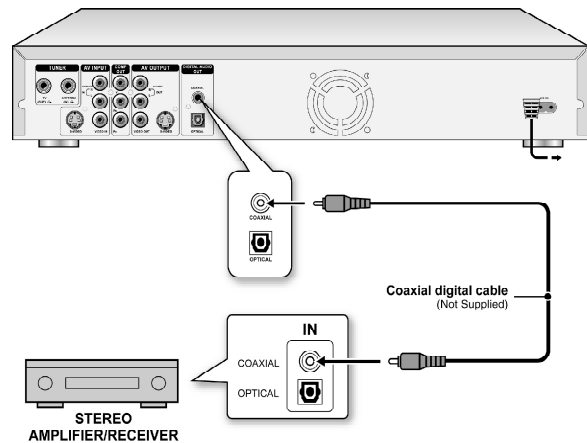

# CONNECTING SATELLITE RECEIVER OR CABLE BOX

## Connecting the cable box/satellite box and television

Before using the unit, follow the steps below to connect the unit to the cable box and TV.

### Connecting to a satellite box or a cable box with COMPOSITE jacks

Use AUDIO/VIDEO cables to connect the AUDIO/VIDEO output of the unit to the AUDIO/VIDEO input on the cable box or satellite receiver.

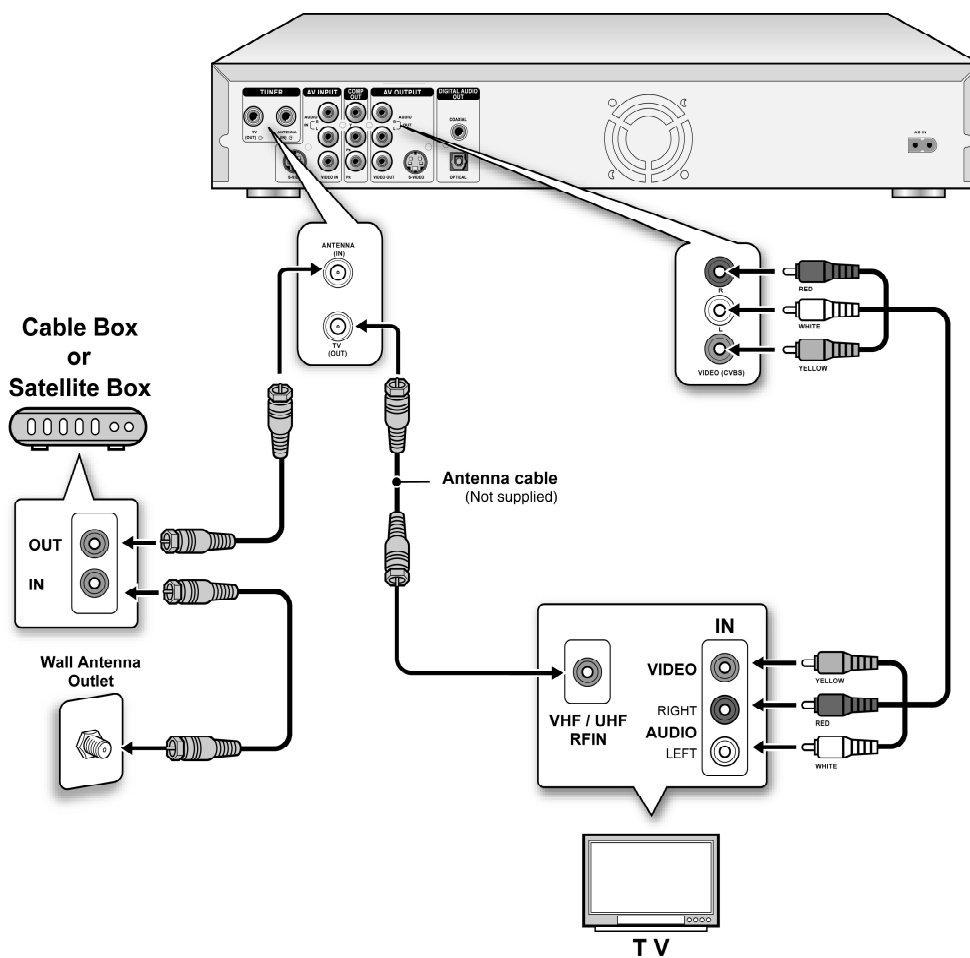

# SYSTEM MENU

## Remote Control & system menu

Follow the steps below to reset personal preferences for using the DVD recorder. Confirm that all connections are secured properly.

1. Press [STANDBY-ON] to turn on the unit.
2. Press [SYSTEM MENU] to display the system menu.
3. Press [▲] [▼] to select "System," "Language," "Playback," "Record," "Audio," "TV Tuner" or "EXIT" and press [◀] [▶] to return to the previous menu.
4. Press [▲] [▼] to select the item you want to change and press [▶] or [OK].  
select "System" icon to set: Video Output, Date and Time  
select "Language" icon to set: OSD  
select "Playback" icon to set: Aspect Ratio  
select "Record" icon to set: Quality ( M1, M2, M2x, M3, M4 and M6)  
select "Audio" icon to set: Digital Output (PCM / Bit Stream)  
(Reference the "GUI operation" section for detailed menu)
5. Press [OK] to confirm the setting.
6. Press [SYSTEM MENU] to exit the system menu or press [◀] to return to the previous menu.

### Note:

To record TV programs using the Timer Record feature, you must set the time accurately.

## Setting the date and time (in SYSTEM category)

A power failure could result in incorrect date/time settings. The correct time needs to be reset.

### Set the date

1. Press the [SYSTEM MENU] button and the system menu will be displayed.
2. Select "System" using [▲] [▼] and press [OK].
3. Select "Date" using [▲] [▼] and press [OK].
4. Change the day/month/year in the highlighted field using [▲] [▼] or the numbered buttons (0-9) on your remote control and confirm by pressing [OK].
5. When all settings are correct, press [◀] to return to the main menu.
6. To exit the system menu, press the [SYSTEM MENU] button.

### Set the time

1. Press [SYSTEM MENU] on the remote control. The system menu will appear.
2. Select "System" using [▲] [▼] and press [OK].
3. Select "Time" using [▲] [▼] and press [OK].
4. Change the "hour/minute/second" in the highlighted field using [▲] [▼] or the numbered buttons (0-9) on your remote control.
5. Change the "AM/PM" mode using [▲] [▼] and confirm by pressing [OK].
6. When all settings are correct, press [◀] until returning to the main level.
7. To exit the system menu, press the [SYSTEM MENU] button.

### Note:

Check that the clock is correctly set before initiating the timer recording function. If the clock is set incorrectly, Timer Record results may not be accurate.

## Setting video output (in SYSTEM category)

1. Press the [SYSTEM MENU] button and the system menu will be displayed.

2. Select "System" using [▲] [▼] and press [OK].
3. Select "video output" as "COMPONENT" or "PROGRESSIVE" using [▲] [▼] and press [OK]. (Reference the "GUI operation" section for details)
4. When all settings are correct, press [◀] to return to the main menu.
5. To exit the system menu, press the [SYSTEM MENU] button.

## Progressive Scan mode

You can change the video output mode when you press the [SYSTEM MENU] button and to select "System-->Video Output-->Progressive."

### Video output mode:

576i: Interlace video      576p: Progressive video



You must connect the component output on the unit to a 576p compatible television.

### Notes:

If you accidentally set "PROGRESSIVE" as the VIDEO OUTPUT when not connecting to a progressive scan-compatible TV, you may lose the video signal on your TV instantly. To get the picture back, press [▶] and the numbered buttons "5," "0," "2" and "0" on the remote control and then [OK] to re-set the video output.

## Setting Aspect ratio (in PLAYBACK category)

Select "4:3" (regular) or "16:9" (widescreen) to suit your television. If you have a regular 4:3 television, you can also select how video title on some discs is presented.

### 4:3 L.Box (4:3 Letter Box)

Select when you connect the unit to a normal (4:3) TV.

When playing back a DVD-VIDEO disc recorded in wide picture format, the picture is shown with black bars at the top and bottom.



### 4:3 Pan (4:3 Pan & Scan)

Select when you connect the unit to a normal (4:3) TV.

When playing back a DVD-VIDEO disc recorded in wide picture format, the picture is zoomed to fill the screen vertically, and the left and right sides of the image are chopped off. Note, however, that the picture will be shown in the 4:3 L. Box (4:3 Letter Box) mode even if you select the 4:3 Pan (4:3 Pan & Scan) mode depending on the disc.



### 16:9 Wide (16:9 Wide Screen)

Select when you connect the unit to a wide-screen (16:9) TV.



## Setting Audio (in AUDIO category)

### Digital Output

PCM / Bit Stream

(Enable digital audio output with PCM or encoded data)

### DTS Out

ON / OFF



# TV CHANNEL SETUP

## TV channel scanning

When the “scan channel” function is activated, the TV channels are searched and stored in a specific order. If the channel assignment of your TV content provider is changed or if you are reinstalling this DVD recorder, you may need to start this procedure again. This will replace the TV channel stored with the new ones.

Before scanning channel, set the “TV signal” and “country” for initiation.

1. Ensure the antennas are securely connected to the DVD recorder.
2. Switch on the TV set and the DVD recorder.
3. Press [SYSTEM MENU] to display the system menu, press [▲] [▼] to select the “TV TUNER” icon and press [▶].
4. Press [▲] [▼] to select “TV signal” and press [▶].
5. Press [▲] [▼] to select “cable,” “antenna” or “auto” depending on how you receive your terrestrial TV channels and press [OK]. Press [◀] to return to the previous menu and save the setting.

If you select “auto,” the unit will automatically scan channels available at both cable and antenna connections, which might take longer than needed.

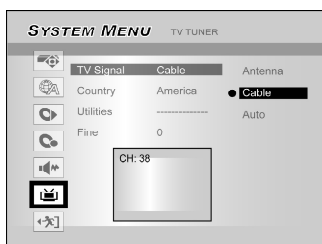

6. Press [▲] [▼] to select “Country” and press [▶]. Press [▲] [▼] to select the country of your residence from the list and press [OK] to save the settings. Press [◀] to return to the previous menu.

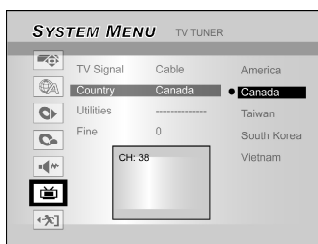

7. Press [▲] [▼] to select “Utilities” and press [▶].
8. Press [▲] [▼] to select “scan channel” and press [OK] to start channel scanning.

If you wish to stop scanning, move to “stop scan” and press [OK]. The scanning process will be discontinued.

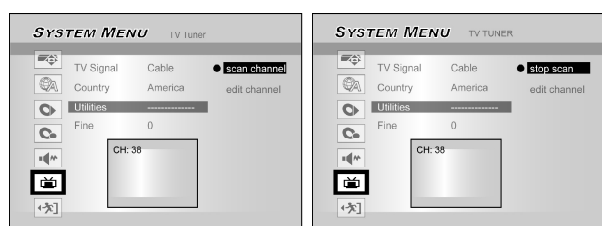

9. The channel scanning starts. This process may take a few minutes.

10. When all the TV channels have been searched and stored, press [SYSTEM MENU] to exit.

### Note:

If the available channel number in your residence area exceeds the maximum receivable channel numbers of this DVD Recorder, the scan will be discontinued. The maximum receivable channel numbers are:

Antenna: 168 (chs)  
Cable: 104 (chs)  
Auto: 168 (chs)

## Fine-tuning TV channels manually

After you have performed the channel scanning, you may like to fine-tune the TV channel signal manually. Follow the steps below to complete fine tune.

1. Press [SYSTEM MENU] to display the “system menu,” press [▲] [▼] to select the “TV TUNER” icon and press [▶].
2. Press [▲] [▼] to select “FINE TUNE” and press [▶].
3. Press [▲] [▼] to fine-tune the channel signal.

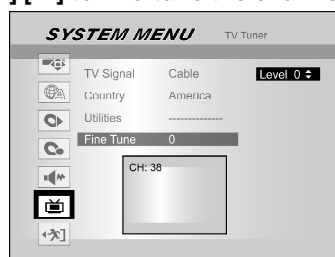

4. When complete, press [SYSTEM MENU] to exit the system menu.

## Editing TV channels manually

After you have performed channel scanning, you may like to further edit the TV channels. This function allows manually adding/deleting channels, swapping channel order, inserting a channel to a specific order, renaming the channels and so on.

1. Press [SYSTEM MENU] to display the “system menu,” press [▲] [▼] to select the “TV TUNER” icon and press [▶].
2. Press [▲] [▼] to select “Utilities” and press [▶].
3. Press [▲] [▼] to select “Edit Channel” and press [▶]. The Channel Editor menu will be displayed.

For detailed operation instructions on the “Channel Editor” menu, refer to the “Channel Editor” section.

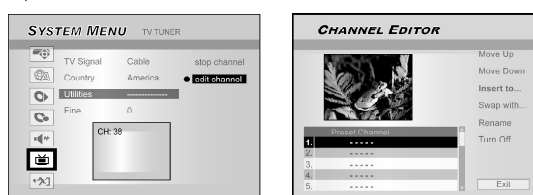

## CHANNEL EDITOR

To access to the Channel Editor menu, press [SYSTEM MENU], select "TV TUNER," "Utilities," "Edit channel" and press [OK]. Or, press [SOURCE] to set "TV" as the input signal source and press [EDIT]. Either way, the Channel Editor menu will be displayed.

### Moving up or moving down the TV channel

1. Press [▲] [▼] to select one of the TV channels and press [▶].
2. Press [▲] [▼] to select "Move Up" or "Move Down" and press [ENTER].

The order of the TV channel will be changed. Each time you press [▲] or [▼] and the item changes as follows:

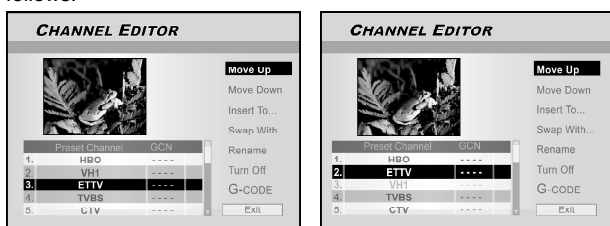

3. To move the location of other TV channels, repeat step 1~2 to complete the settings.
4. Press [◀] [▶][▲] [▼] to select "EXIT," press [ENTER] to save the setting and exit the "Channel Editor" menu.

### Inserting TV channels

1. Press [▲] [▼] to select a TV channels and press [▶].
2. Press [▲] [▼] to select "Insert To" and press [ENTER].
3. Press [◀] [▶][▲] [▼] to enter the "Channel number," and press [ENTER]. The channel will be moved to the desired location.

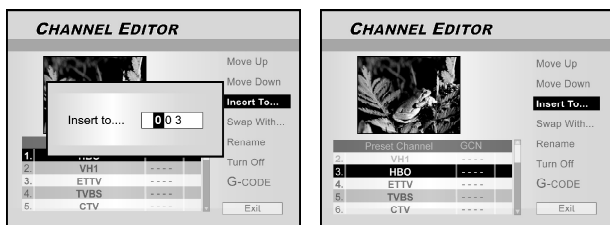

4. To change the locations of other TV channels, repeat step 1~3 to complete the settings.
5. Press [◀] [▶][▲] [▼] to select "EXIT," press [ENTER] to save the setting and exit the "Channel Editor" menu.

### Swapping TV channels

This function allows you to manually swap the TV channel order stored in the unit to match the TV channel order stored in your TV set.

1. Press [▲] [▼] to select a TV Channel and press [▶].
2. Press [▲] [▼] to select "Swap with" and press [OK].
3. Press [◀] [▶][▲] [▼] to enter the "Channel number," and press [OK] to swap. The order of the channels will be swapped with the channel number entered.
4. To swap other TV channels, repeat step 1- 3 to complete the settings.
5. Press [◀] [▶][▲] [▼] to select "EXIT," press [OK] to save the setting and exit the "Channel Editor" menu.

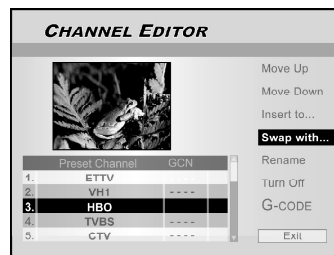
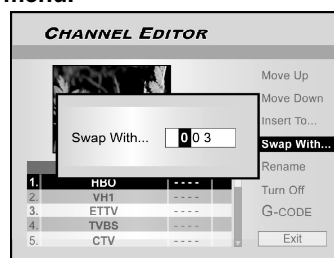

### Renaming TV channels

1. Press [▲] / [▼] to select a TV channel and press [▶].
2. Press [▲] [▼] to select "Rename" and press [OK].  
The display for entering a title name appears.
3. Select the desired characters from the keypad. Press [OK] after each entry.
4. When you finish entering the title name, press [◀] [▶] [▲] [▼] to select "Finish" to press [OK].

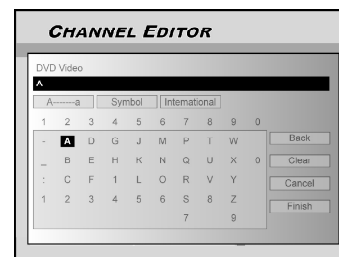

#### Notes:

You can only enter up to 10 characters for a name.

## CHANNEL EDITOR

### Turning on or turning off TV channels manually

After you have performed the channel scanning process, you may like to add or delete some of the TV channels. This function allows turning on the channel not found at channel scanning or turning off the channel found manually.

1. Press [▲] [▼] to select a TV Channel not found at channel scanning and press [▶].
2. Press [▲] [▼] to select "Turn on" and press [OK]. The TV channel selected will be turned on.  
To turn off the TV channel, move to "Turn off" and press [OK]. The TV channel selected will be turned off.
3. To turn on other TV channels, repeat step 1~ 2 to complete the settings.
4. Press [◀] [▶] [▲] [▼] to select "EXIT," press [OK] to save the setting and exit the "Channel Editor" menu.

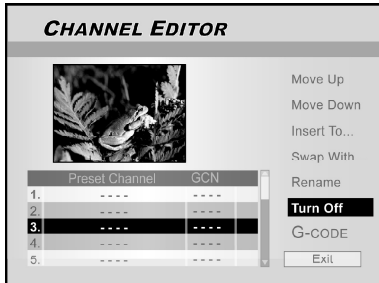
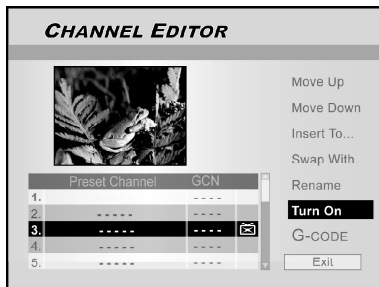

## Setting up G-Code® system

Thanks to this programming system, you no longer need to tediously enter the date, programme number, start and end times. All the information needed by the DVD recorder for programming is contained in the G-Code® programming number. This 9-digit G-Code® programming number is found in most TV listings magazines.

Before setting up, confirm that all cables are securely connected.

### Setting up the G-Code® system

1. Press the [SOURCE] button to set TV as the input signal source.
2. Press [EDIT] to display the "Channel Editor" menu.
3. Press [▲] [▼] to go to a channel and press [OK].
4. Press [◀] [▶] [▲] [▼] to go to "G-Code" button and press [OK].

The menu to enter GCN is displayed.

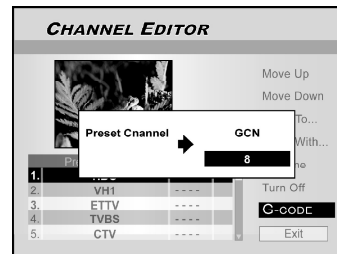

5. Use the numbered buttons (1~9) to enter the GCN and press [OK] when done.

Press [◀] [▶] to go back to advance/return to the previous/next digit.

6. To set GCN for other channels, repeat steps 3~5.

7. When complete, press [▲] [▼] to go to "EXIT" and press [OK] to exit the channel editor menu.

## GUIDE MENU: PLAYBACK

Guide menu is a unique user interface to guide you through basic functions of this recorder. By using the Guide menu, it is less time-consuming to operate this system. Users no longer need to go through normal operations that may require far more steps and different interfaces.

### Playback video files

1. Press [**GUIDE**] to display the Guide menu.
2. Press [**▲**] [**▼**] to select “Playback” and then press [OK].

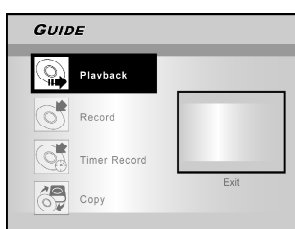

3. Press [**▲**] [**▼**] to select DVD or HDD and then press [OK].



4. Press [**▲**] [**▼**] to select “Video” and press [OK].

The browser menu is displayed.

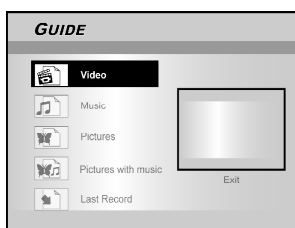

5. Press [**◀**] [**▶**] [**▲**] [**▼**] to select a title (program) you want to play and press [OK].

If you want to go to the next page or return to the previous page, you can select the [**◀◀**] [**▶▶**] icon or the page number icon.



6. Press [**||▶**] PAUSE] to pause playback. Press [**▶**] PLAY] to resume normal playback. Press [**■**] STOP] to stop playback at a marked stop. Press [**■**] STOP] twice to bring the playback to a full stop.

### Playback music files

1. Press [**GUIDE**] to display the Guide menu.
2. Press [**▲**] [**▼**] to select “Playback” and then press [OK].
3. Press [**▲**] [**▼**] to select DVD or HDD and then press [OK].
4. Press [**▲**] [**▼**] to select “music” and press [OK].

The browser menu is displayed.

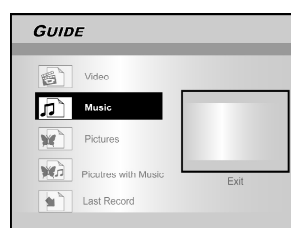

5. Press [**◀**] [**▶**] [**▲**] [**▼**] to select a music file you want to play and press [OK].

If you want to go to the next page or to the return previous page, you can select the [**◀◀**] [**▶▶**] icon or the page number icon.

6. Press [**||▶**] PAUSE] to pause playback. Press [**▶**] PLAY] to resume normal playback. Press [**■**] STOP] to stop playback.

### Playback picture files

1. Press [**GUIDE**] to display the Guide menu.
2. Press [**▲**] [**▼**] to select “Playback,” and then press [OK].
3. Press [**▲**] [**▼**] to select DVD or HDD and then press [OK].
4. Press [**▲**] [**▼**] to select “Pictures” and press [OK].

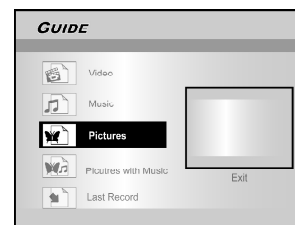

5. Press [**◀**] [**▶**] [**▲**] [**▼**] to select a picture file you want to play and press [OK].

If you want to go to the next page or return to the previous page, you can select the [**◀◀**] [**▶▶**] icon or the page number icon.

6. Press [**||▶**] PAUSE] to pause playback. Press [**▶**] PLAY] to resume normal playback. Press [**■**] STOP] to stop playback.

## GUIDE MENU: PLAYBACK, RECORD

### Playback pictures with music

1. Press [**GUIDE**] to display the Guide menu.
2. Press [**▲**] [**▼**] to select "Playback" and then press [**OK**].
3. Press [**▲**] [**▼**] to select DVD or HDD and then press [**OK**].
4. Press [**▲**] [**▼**] to select "Pictures with music" and press [**OK**].

The browser menu of picture files will be displayed.



5. Press [**▲**] [**▼**] [**◀**] [**▶**] to select the picture file to start playback with and press [**OK**].  
The browser menu of audio files will be displayed.
6. Press [**▲**] [**▼**] [**◀**] [**▶**] to select the music file to start playback with and press [**OK**].  
Playback will start.
7. Press [**▲**] [**▼**] to select "Rotate RIGHT" or "Rotate LEFT" and "Rotate UP" "Rotate down."  
Press [**◀**] or [**▶**] to skip the picture.  
Press [**▶▶**] [NEXT] or [**◀◀**] [PREVIOUS] to skip the MP3 file.
8. Press [**||▶**] [PAUSE] to pause playback.  
Press [**▶**] [PLAY] to resume normal playback .  
Press [**■**] [STOP] to stop playback.

### Playback the last recorded title (on HDD only)

1. Press [**GUIDE**] to display the Guide menu.
2. Press [**▲**] [**▼**] to select "Playback" and then press [**ENTER**].
3. Press [**▲**] [**▼**] to select HDD and press [**OK**].
4. Press [**▲**] [**▼**] to select "Last Record" and press [**OK**].

Playback of the title last recorded on your HDD will begin.

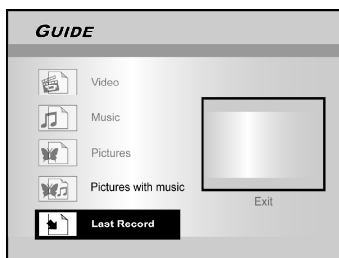

5. Press [**||▶**] [PAUSE] to pause playback.  
Press [**▶**] [PLAY] to resume normal playback .  
Press [**■**] [STOP] to stop playback at a marked stop.  
Press [**■**] [STOP] twice to bring the playback to a full stop.

### Record on the HDD

1. Press [**GUIDE**] to display the Guide menu.
2. Press [**▲**] [**▼**] to select "Record" and then press [**OK**].

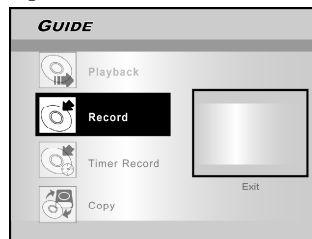

3. Press [**▲**] [**▼**] to select the Signal- Input ( TV, AV1, AV2, S-Video, DV) and press [**OK**].

If you select "TV," press [**▲**] [**▼**] to select the channel you want to record and press [**OK**].

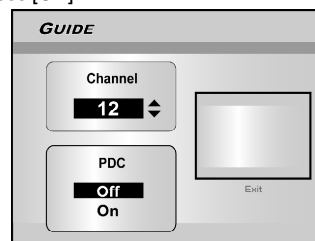

4. Press [**▲**] [**▼**] to select "HDD" and press [**OK**].

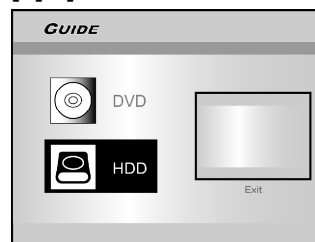

5. Press [**▲**] [**▼**] to select "Recording mode" and then press [**OK**].

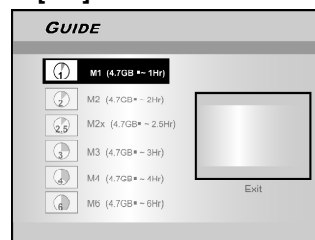

If you select "TV" in step 3, press [**▲**] [**▼**] to select TV audio and press [**OK**].

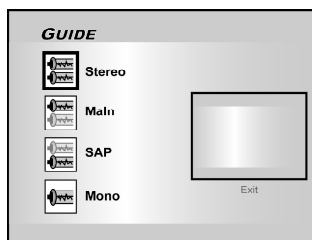

6. Press [**OK**] to start recording.  
Press [**■**] [STOP] to stop recording.  
Press [**||▶**] [PAUSE] to pause recording.

#### Note:

You can press the [GUIDE] button to exit the Guide menu.

# GUIDE MENU: RECORD, TIMER RECORD

## Record on DVD

1. Press [ GUIDE] to display the Guide menu.
2. Press [▲] [▼] to select "Record" and then press [OK].

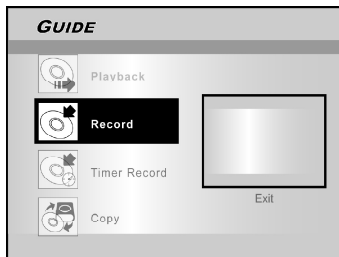

3. Press [▲] [▼] to select the Signal-Input (TV, AV1, AV2, S-Video, DV) and press [OK].  
If you select "TV," press [▲] [▼] to select the channel you want to record and press [OK].
4. Press [▲] [▼] to select "DVD" and press [OK].
5. Press [▲] [▼] to select "Recording mode" and then press [OK].

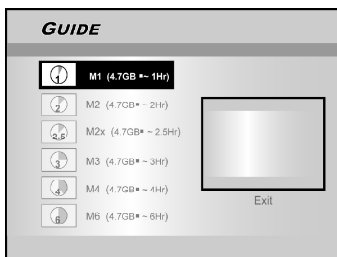

If you select "TV" in step 3, press [▲] [▼] to select TV audio and press [OK].

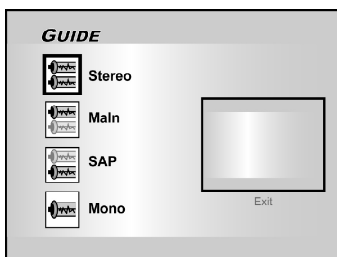

6. Press [OK] to start recording.  
Press [ STOP] to stop recording.  
Press [ PAUSE] to pause recording.

### Note:

When placing an recordable DVD disc on the disc tray, the disc preparation process will take place in the background. This process only takes a few moments.

## Timer Record (Date/Time Setting)

1. Press [ GUIDE] to display the Guide menu.
2. Press [▲] [▼] to select "Timer Record" and then press [OK].

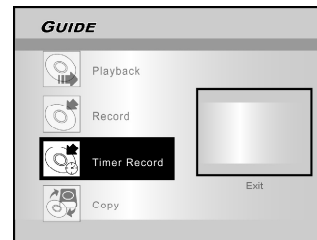

3. Press [▲] [▼] to select "Date/Time Setting" and press [OK].

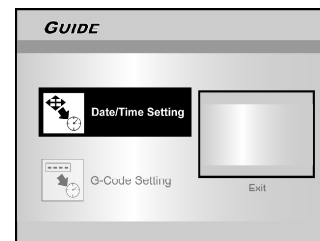

4. Press [▲] [▼] to select the Signal-Input (TV, AV1, AV2, S-Video, DV) and press [OK].  
If you select "TV," press [▲] [▼] to select the channel you want to record and press [OK].

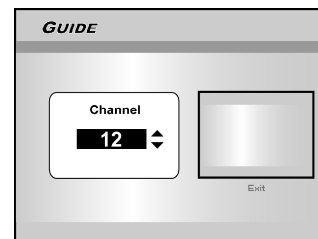

5. Press [▲][▼] to select "Once," "Daily," or "Weekly."

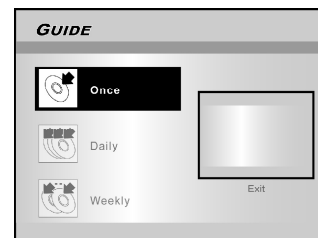

6. Press [▲][▼][◀] [▶] or the numbered buttons (0~9) to set the date and press [OK] when done.

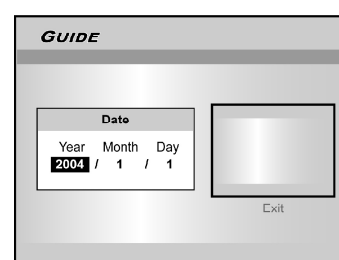

## GUIDE MENU: TIMER RECORD

7. Press [▲][▼][◀][▶] or the numbered buttons (0~9) to set the time and press [OK] when done.

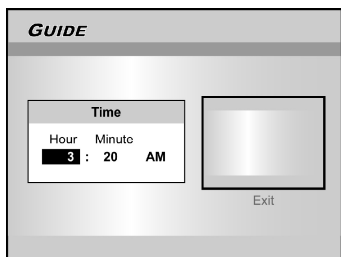

8. Press [▲][▼] to set "Length" and then press [OK].

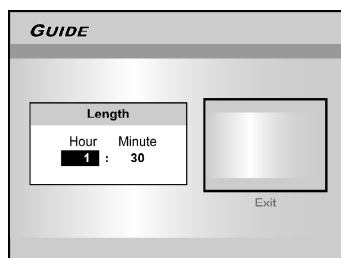

9. Press [▲][▼] to select "Device" and then press [OK].

10. Press [▲][▼] to select "Recording mode" and press [OK].

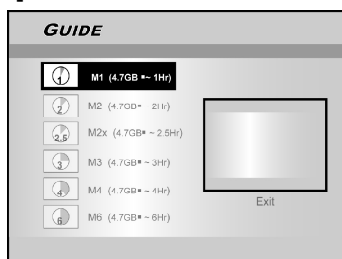

### Note:

For Timer Record, there are seven recording modes for recording on DVD disc: M1, M2, M2x, M3, M4, M6 and Just Fit. The "Just Fit" recording mode is only applicable when recording onto DVD disc. When the recording mode is set to be "Just Fit," the recording mode will be automatically adjusted depending on how much recording space is available on the disc.

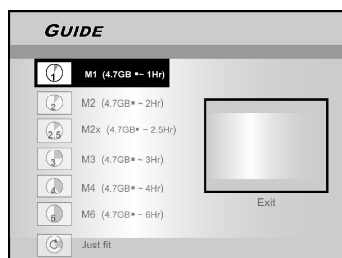

If you select "TV" in step 4, press [▲][▼] to select TV audio and press [OK].

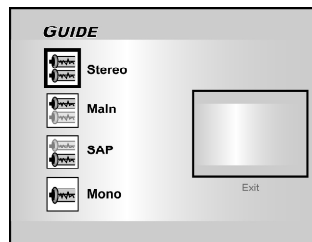

11. The "Timer Record information" will appear and press [OK] to confirm the settings.

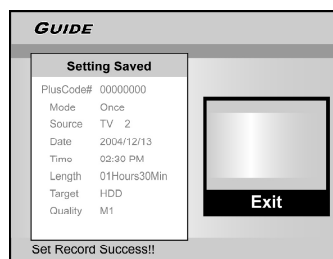

13. Press [▶] and [OK] to exit the timer record settings.

14. Press [STANDBY-ON] to turn the recorder off to activate Timer Record function.

## Timer Record (G-Code® Setting)

1. Press [GUIDE] to display the Guide menu and press [OK].

2. Press [▲][▼] to select "Timer Record" and then press [OK].

3. Press [▲][▼] to select "G-Code Setting" and press [OK].

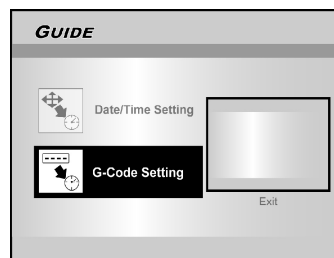

4. Press [▲][▼] to select once, daily or weekly and press [OK].

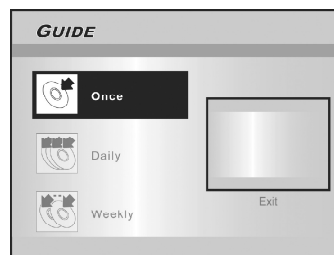

## GUIDE MENU: TIMER RECORD, COPY

6. Use the numbered buttons to enter the G-Code programming number and then press [OK].

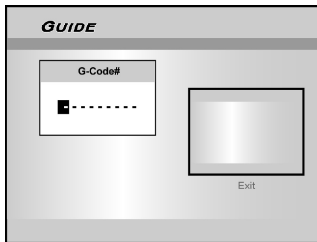

7. After entering the G-Code programming number, the “GCN” and “Present channel number” will be displayed. Press [OK] to set the preset the channel.

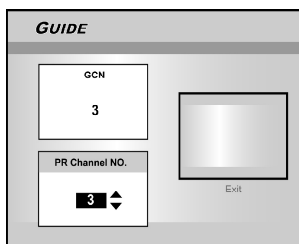

8. Press [▲][▼] to select “DVD” or “HDD” and then press [OK].

9. Press [▲] [▼] to select “Recording mode” and then press [OK].

The “Just Fit” recording mode is only applicable when recording on a DVD disc.

10. Press [▲] [▼] to select TV audio and press [OK].

11. The “Timer Record information” will be displayed. Press [OK] to confirm the settings.

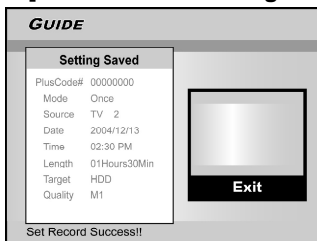

11. Press [▶] and [OK] to exit the G-Code setting® menu.

12. Press [STANDBY-ON] to turn the recorder off to activate Timer Record function.

### Copy (From HDD to DVD)

1. Press [GUIDE] to display the Guide menu.

2. Press [▲] [▼] to select “Copy” and press [OK].

#### Note:

You can only copy picture files (in JPEG or BMP formats), audio files (in MP3 format) and recorded video titles.

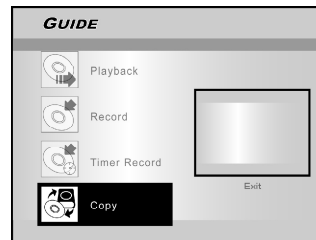

3. Press [▲] [▼] to select “From HDD to DVD” and press [OK].

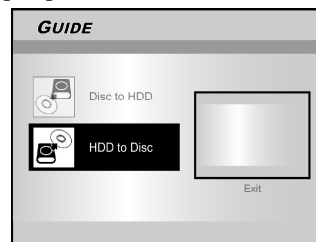

4. Press [▲ OPEN/CLOSE] to open the disc tray and insert a recordable DVD disc. Press the button again to close the tray.

The disc preparation process will take place in the background. This process only takes a few moments.

5. Press [▲] [▼][◀] [▶] to select the file to copy and press [OK].

6. When complete, go to “EXIT” and press [OK].

### Copy (From DVD to HDD)

1. Press [GUIDE] to display the Guide menu.

2. Press [▲] [▼] to select “Copy” and press [OK].

3. Press [▲] [▼] to select “From DVD to HDD” and press [OK].

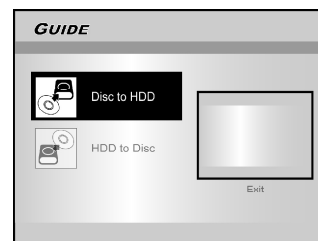

4. Press [▲ OPEN/CLOSE] to open the disc tray and insert the DVD disc. Press the button again to close the tray.

5. Press [▲] [▼][◀] [▶] to select the file to copy and press [OK].

6. When complete, go to “EXIT” and press [OK].

#### Note:

You can only copy picture files (in JPEG or BMP formats), audio files (in MP3 format) and recorded video titles.



# RECORDING

## Before recording

### Cautions:

1. This DVD recorder records on both DVD+R/+RW discs and the built-in HDD.
2. Please use recommended recordable DVD+R/RW discs to ensure the best recording quality.
3. DVD+R is a write-once DVD disc.
4. DVD+RW is a re-writable DVD disc.
5. You cannot add new recording to DVD+R discs after the disc is finalized.
6. In some cases, you may not be able to add new recording to the recordable DVD discs that contain contents written on other DVD recorders.

## Recording television programs

1. Press [STANDBY-ON] to turn the unit on.

2. Press the [HDD/DVD] button to set the target device as "HDD" or "DVD."

If "DVD" is selected as the target device, press [▲ OPEN/CLOSE] to open the disc tray and insert a recordable DVD disc. Press the button again to close the tray. When you insert a new recordable DVD disc, the DVD recorder automatically starts the disc preparation process.

3. Press [SOURCE] and press [▲] [▼] to select "TV" as the signal-input source.

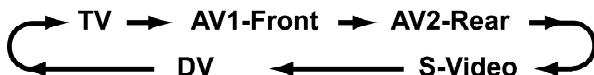

4. Press [CH +] [CH -] or press [▲] [▼] to select the TV channel you want to record.



### Notes:

You can also use the numbered buttons to select a channel.

4. Press [RECORD] to start recording. When recording is completed it may take a few moments for the session to close.



Recording continues until you stop the recording or when the DVD disc or the HDD is full.

### To stop recording

When you press [■ STOP], it may take a few moments for recording to stop and the session to close.



### To pause recording

Press [|| PAUSE] to pause recording, and press [|| PAUSE] again to resume recording.



### To change the recording mode before recording:

Press [SYSTEM MENU] button.

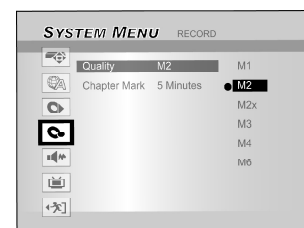

### To change the TV Audio setting before recording:

Press [SETUP] button.



### Notes:

The new setting can't change the current recording mode but will be activated during the next recording session.

### To check the disc status while recording

Press [DISPLAY], the recording information appears.

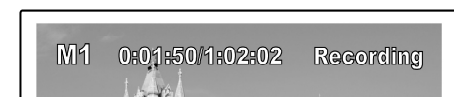

# RECORDING

## Adding new recordings

Adding new recordings after other recording sessions.

Press [RECORD] to start recording, and press [STOP] at the point you want to stop.



### Note:

Each new recording session is placed after the previous session unless a certain recording title is set to be overwritten. (Reference the "Overwrite" function in the "Editing" section for additional details.)

## Change Chapter Intervals

### Creating chapters while recording

The DVD recorder can automatically divide a session into chapters by inserting chapter marks at 5/10/15/20/25/30-minute interval during the recording process.

1. Press [SYSTEM MENU] to display the system menu.
2. Press [▲] [▼] to select the "RECORD" and press [▶].
3. Press [▲] [▼] to select "CHAPTER MARK" to set up the interval time.

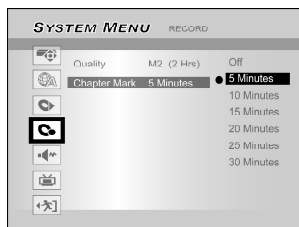

4. Press [SYSTEM MENU] to exit the system menu.

### Notes:

1. During recording, press [EDIT] to add chapter mark(s) in the recorded session manually.
2. You can also start recording using the "Guide Menu." Press [GUIDE], select "RECORD" and press [OK]. Follow the steps to set the recording mode.
3. Before you start, please ensure that the DVD disc or hard disk has enough available space for the recording session.
4. You cannot change the channel or recording mode during recording.

## Playback the last recorded title (on HDD only)

Press [▶PLAY] or [GUIDE] to start the playback of the last recorded title.

This function is only available when the desired title resides on the HDD.

### Using [▶PLAY]

1. Press [▶PLAY] and the last recorded title will start playback.

### Using [GUIDE]

1. Press [GUIDE] and select the "PLAYBACK" icon.
2. Confirm that the playback device is HDD.
3. Press [▲] [▼] to go to the "Last Record" icon and press [OK]. The playback will start.

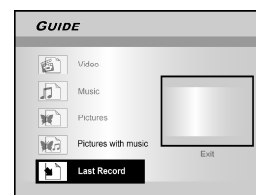
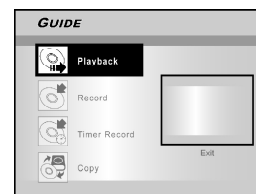

### Notes:

1. If a power failure occurs, the program you are recording may be lost.
2. Before you start, please check that the DVD disc or hard disk has enough available space for the recording.
3. You can not change the recording mode during recording.
4. Before playing a DVD+R disc on another player, you first need to **finalize** the disc.

# RECORDING

## Recording from a VCR or Camcorder

### Before starting to record

This DVD recorder can accept standard CVBS (RCA) analog audio/video cable or IEEE-1394 cable and record Camcorder onto DVD in the digital video format of your choice. The unit functions much like a digital VCR. Examples of use include archiving videotapes or transferring from a Video Cassette Recorder or Camcorder to a recordable DVD disc or hard disk drive. This DVD recorder allows basic DV control with the DVD Recorder's remote control when connected via the DV Link.

### The front panel and rear panel connection

Connect a Video Cassette Recorder or Camcorder to the unit's input terminals.

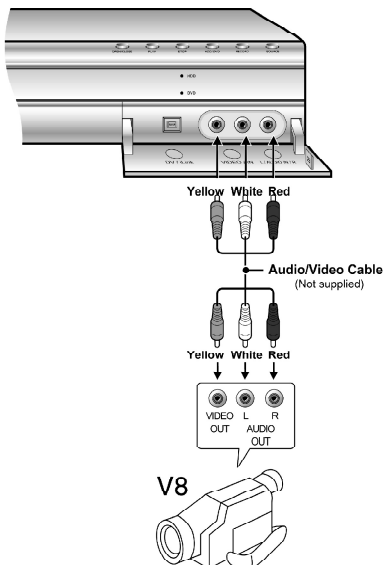
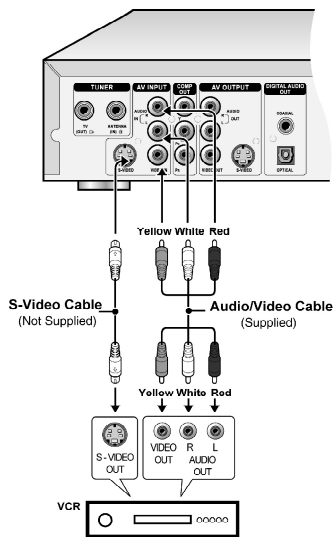

### To start recording

1. Press the [HDD/DVD] button to set the target device for the recording.
2. Press [SOURCE] to select the signal-input (TV, AV1-Front, AV2-Rear, S-Video, DV).

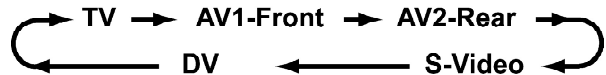

3. Start to play on the VCR or Camcorder.
4. Press [RECORD] to capture your video/audio signal from the VCR or Camcorder onto a recordable DVD disc or hard disk.



5. Press [■ STOP] to stop recording.

### To pause recording

Press [||▶ PAUSE] to pause recording. If you want to restart recording, press the [||▶ PAUSE] button to resume recording.

# RECORDING

## One-touch recording

Use “One-touch recording” to start recording immediately in 30-minute blocks. Press [RECORD] twice to start a 30-minute recording session. Press [RECORD] repeatedly to record longer timed recordings, up to 6 hours in thirty-minute increments. Pressing [RECORD] when the timed recording exceeds the 6-hour constraint automatically sets “one-touch recording” off. For recording on DVD discs, the length of recording depends on the current recording mode/speed and the amount of time available on the disc. For recording on the built-in HDD, the length of recording is 6 hours maximum.

## DV recording

### Before you start to record DV contents

This DVD recorder allows basic DV control functions with the remote control. The DVD recorder is equipped with a camcorder control (Play, Stop, FF or REW) feature via the DV Link connection. Simply move the screen cursor to the desired function on the DV input screen and press [OK] on the remote control.

### Use “Guide Menu” to record DV signal

1. Power on your TV and this DVD recorder.
2. Connect the DV cable (IEEE-1394 4-pin to 4-pin cable) to both the DV Camcorder and the DVD-Recorder.

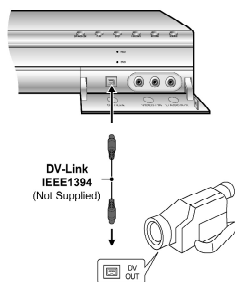

3. Power on the DV Camcorder. Start “Playback mode” on the DV Camcorder.
4. “Pause” the DV Camcorder at where you want to record.
5. Press [ ] on the remote control. This activates the Guide menu.
6. Press [ ] [ ] to select the “RECORD” icon, and press [OK] to start recording.



7. Press [ ] [ ] to select “DV” and press [OK] to confirm.

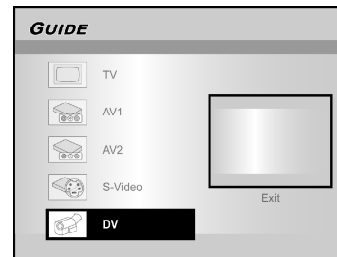

8. Press [ ] [ ] to select HDD or DVD and press [OK].



9. Press [ ] [ ] to set the recording quality, and press [OK] to confirm.

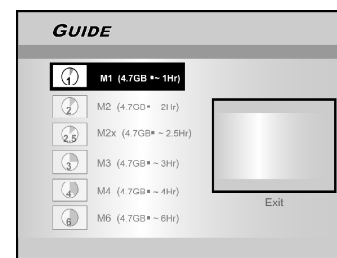

10. Press [OK] to start recording.

### Notes:

This DVD-Recorder will stay in “Pause” mode when no DV input signal is detected.

### 11.To pause recording.

Press [ ] on the remote control to pause recording. Press [ ] again, if you want to resume recording.

### 12.To stop recording.

Press [ ] to stop recording.

### Note:

Before playing a DVD+R disc on another player, you will first need to **finalize** the disc. Reference the “finalize” function in the “Disc Tools” section for additional information.

# RECORDING

## DV Recording (Con't)

### Before you start to record DV contents

This unit allows basic DV control on-screen. The on-screen functions are accessed using the DVD recorder remote control.

1. Power on your TV and this DVD recorder.
2. Press the [HDD/DVD] button to set the target device for the recording.

If "DVD" is set as the target device, press [▲ OPEN/CLOSE] to open the disc tray and insert a recordable DVD disc with the label side facing up.

3. Connect the DV Cable (IEEE-1394 4-pin to 4-pin cable) to both the DV Camcorder and this DVD recorder.
4. Power on the DV Camcorder. Set "Playback mode" on the DV Camcorder.
5. "Pause" the DV Camcorder at where you want to record.
6. Press [SOURCE] to change the signal-Input source and select "DV."

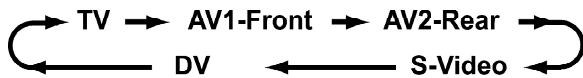

7. Resume DV Camcorder playback and press [RECORD] on the DVD Recorder to start recording.



### 8. To pause recording.

Press [||▶ PAUSE] on the remote control to pause recording. Press [||▶ PAUSE] again, if you want to resume recording.

### 9. To stop recording.

Press [■] to stop recording.

## DV control

After recording is stopped, a DV control bar will appear on the screen. This allows basic DV control utilizing this DVD recorder's remote control.



1. Press [◀] [▶] to select (▶▶) to fast-forward the DV Camcorder.
2. Press [◀] [▶] to select (◀◀) to rewind the DV Camcorder.
3. Press [◀] [▶] to select (■) to stop the DV Camcorder playing.
4. Press [◀] [▶] to select (▶) to start the DV Camcorder playing.
5. Press [◀] [▶] to select (||) to pause the DV Camcorder playing.

### Notes:

1. The DV-Link input jack on this unit is for use with DV compatible camcorders only.
2. Only DV signals can be input to the DV-Link jack on this DVD recorder.
3. Do not connect a MICRO MV format video camcorder to this DV-Link (IEEE-1394) jack.

# TIMER RECORD

## Prior to timer record

Please ensure that the recordable DVD disc or the HDD has enough available space for the Timer Record function. Before you start to record, follow the steps to set the date, time, picture quality and channel of the program or input source manually. You can set up 16 individual sessions in the Timer Recording function.

## Setting the timer

1. Press [STANDBY-ON] to turn the unit on.

2. Press [TIMER] to display the "Timer Record" menu.

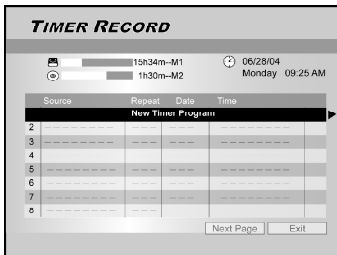

3. Press [▲][▼] to select an item from the timer setting list and press [OK] to activate the system setup menu for the Timer Record function.



4. Press [◀] [▶] [▲][▼] to select the "Source (Signal Source)," and then press [OK] to bring up the list.

Press [▲] [▼] [◀] [▶] and [OK] to make your selection.

5. Press [◀] [▶] [▲][▼] to select the "Channel (TV Channel)," and then press [OK] to bring up the list. This step only applies when the "TV" is selected as the source.

Press [▲] [▼] [◀] [▶] and [OK] to make your selection.

6. Press [◀] [▶] [▲][▼] to select the "HDD/DVD," and then press [OK] to bring up the list.

Press [▲] [▼] [◀] [▶] and [OK] to make your selection. If "DVD" is set as the target device, press [▲] [OPEN/CLOSE] to open the disc tray and insert a recordable DVD disc.

7. Press [◀] [▶] [▲][▼] to select the "Quality (Recording Quality)," and then press [OK] to bring up the list.

Press [▲] [▼] [◀] [▶] and [OK] to make your selection.

8. Press [◀] [▶] [▲][▼] to select the "Repeat (once, daily or weekly)," and then press [OK] to bring up the list.

If you select "Once," you need to set the date. Move the cursor to highlight "date" and press [OK]. Use the numbered buttons (0-9) or [▲] [▼] [◀] [▶] to enter the date.



If you select "daily," you do not need to set the date since the Timer Record is set for each day until it is cancelled or the media is full.



If you select "weekly," a weekly calendar will display on the screen for you to select the day. Press [▲] [▼] [◀] [▶] to move the cursor to highlight the desired day and press [OK] to make your selection. When completed, move the cursor to "EXIT" and press [OK] to save the desired setting.



## Notes:

If the mode is set as "daily" or "weekly," press [◀] [▶] [▲] [▼] to move the highlighted cursor to the "advanced" icon and press [OK]. You can choose to apply the setting "without restriction" or "with restriction." When "with restriction" is selected, enter the "START" date and "END" date to set the period of time for a valid setting. Move the highlighted cursor to "OK" and press [OK] to confirm the setting or to "CANCEL" and press [OK] for resetting.





# TIMER RECORD

9. Press [◀] [▶] [▲] [▼] to select the “Start (Start Time),” and then press [OK] .

Use the numbered buttons (0~9) or press [▲] [▼] [◀] [▶] to enter the start time.



10. Press [◀] [▶] [▲] [▼] to select “End (End Time),” and then press [OK].

Use the numbered buttons (0~9) or press [▲] [▼] [◀] [▶] to enter the end time.



## If you enter a wrong selection

Press [◀] [▶] to re-select the item you want to change.

11. If you select “TV” in step 4, press [◀] [▶] [▲] [▼] to select “SOUND (TV AUDIO)” and then press [OK] to bring up the list.

Press [▲] [▼] [◀] [▶] and [OK] to make your selection.

12. Press [▲] [▼] to select “OK” to save the setting for the timer record item and go back to the Timer Record list.

Press [▲] [▼] [◀] [▶] to [RESET] if you want to reset the timer record item.

13. Press [▲] [▼] to go to another item on the list and press [OK] if you want to set up for more Timer Record programs.

If not, move to the “EXIT” icon and press [OK] to exit the Timer Record List.

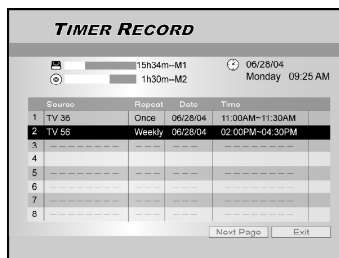

14. Press [STANDBY-ON] to turn off the unit and activate the “Timer Record” function.

## To stop recording during Timer Record

When you press [■ STOP] , it may take a few seconds for the record to stop.

## To check the recording status while Timer Record is active

Press [DISPLAY] and the Timer Record information appears on-screen.

### Notes:

- When the Timer Record function is active, the “Timer LED” on the DVD Recorder front panel will illuminate.
- The DVD recorder must be turned off to activate the Timer Record function.

## Timer Record using the G-Code® system

1. Press [STANDBY-ON] to turn the unit on.

2. Press [TIMER] to display the “Timer Record” menu.

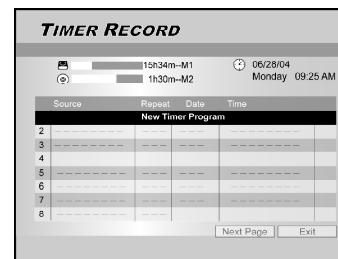

3. Press [▲] [▼] to select an item from the timer setting list and press [OK] to activate the setup menu for the Timer Record function.

4. Press [◀] [▶] [▲] [▼] to select the “G-Code” button and then press [OK] to bring up setup menu. Or press [G-Code] to bring up the G-Code menu.

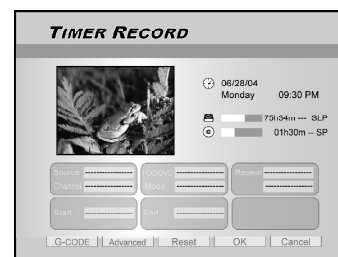

5. Press [◀] [▶] [▲] [▼] to select “Repeat (once, daily or weekly),” and then press [OK] to bring up the list.

Press [▲] [▼] [◀] [▶] and [OK] to make your selection.

6. Press [◀] [▶] [▲] [▼] to select the “G-Code” button and then press [OK] to enter the number.

Use the numbered buttons (0~9) or [▲] [▼] [◀] [▶] to enter the G-Code programming number.

## TIMER RECORD

7. Press [◀] [▶] [▲][▼] to select “HDD/DVD,” and then press [OK] to bring up the list.

Press [▲] and [OK] to make your selection.

If “DVD” is set as the target device, press [▲ OPEN/CLOSE] to open the disc tray and insert a recordable DVD disc.

8. Press [◀] [▶] [▲][▼] to select “Quality (Recording Quality),” and then press [OK] to bring up the list.

Press [▲] and [OK] to make your selection.

Press [◀] [▶] to re-select the item you want to change.

9. Press [◀] [▶] [▲][▼] to select “SOUND (TV AUDIO)” and then press [OK] to bring up the list.

Press [▲] [▼] [◀] [▶] and [OK] to make your selection.

10. Press [▲][▼] to select “OK” to save the setting for the timer record item and go back to the Timer Record list.

11. Press [▲] [▼] to go to another item on the list and press [OK] if you want to set up for more Timer Record programs.

If not, move to the “EXIT” icon and press [OK] to exit the Timer Record List.

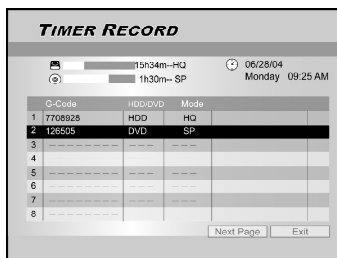

13. Press [STANDBY-ON] to turn off the unit and activate the “Timer Record” function.

### Notes:

1. If you want to go back to the normal Timer Record menu, move to the “Date/Time Setting” icon and press [OK].
2. The DVD recorder must be turned off to activate the Timer Record function.



## FLEX TIME

The "Flex Time" feature allows you to "Pause Live TV" and resume viewing at the point of interruption, at your leisure.

**Note:** "Pause Live TV" is constrained within 3 hours.

### Pausing Live TV Broadcast

1. Press [ STANDBY-ON] to turn the unit on
2. Switch on your TV and set the video input to this recorder.
3. Press [ CH+] [CH-] buttons on the recorder's remote control to select the desired channel.

Since the TV's video input is set to be the recorder, channel selection HAS to be made with the recorder's remote control. To turn the audio volume up and down, use the TV's remote control.

4. When you choose to leave your TV and must stop watching, press [FLEX TIME].

When [FLEX TIME] is pressed the video broadcast on TV is set in pause mode. The scene displayed on the TV is the last picture shown when you press the [FLEX TIME] button.



5. When you are back in front of the TV and ready to resume viewing, press [▶PLAY] and the TV program will begin playing starting from the interrupted scene.
6. Press [▶▶F.F.] or [◀◀REW] to perform fast-forward or fast rewind scanning (to the point where [FLEX TIME] begins). Press [||▶ PAUSE] to pause viewing. Press [||▶ PAUSE] again if you want to resume viewing.
7. Press [FLEX TIME] to turn the time shift function off and switch to viewing live TV broadcast.

### Record and Play

Follow the steps below to start playback of the recorded program before the recording is scheduled to end.

1. During recording, press [▶PLAY].

Playback will start from the beginning of the recorded program.



2. Press [▶▶F.F.] [◀◀REW] to perform fast-forward or fast rewind scanning. Press [||▶ PAUSE] to pause playback. Press [||▶ PAUSE] again if you want to resume viewing.

RECORDING PAUSED 

Press [■ STOP] to stop playback/viewing.



#### Caution:

If you press [STOP] again, the recording function will be turned off.

3. If you want to stop recording, press [■ STOP] for a second time.

RECORDING STOPPED 

# PLAYBACK

## DVD/VCD/SVCD video disc playback

Before you begin to enjoy the digital world of audio and video on DVDs, please ensure that you have made the correct settings in the Setup menus. These settings should correspond to the capabilities of your home system. Having made the correct settings, you are now ready to use the DVD recorder to enjoy DVDs, Video CDs, and CDs.

### Basic playback

Turn on the television and select the appropriate video input on the television to suit the connections for the player.

- Press [ **STANDBY-ON** ] to turn on the unit.

Press to turn the unit on or off.

- Press [ **OPEN/CLOSE** ] to open the disc tray. Place the disc in the tray, label-side up.

- Press [ **PLAY** ] to start playback.

- Press [ **F.F.** ] to perform fast forward scanning.

Press repeatedly to play the disc forward at 2x, 4x, 8x, or 16x speeds.

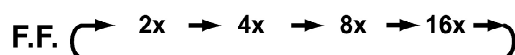

- Press [ **REW** ] to perform fast reverse scanning.

Press repeatedly to play the disc reverse at 1x, 2x, 4x, 8x, or 16x speeds.

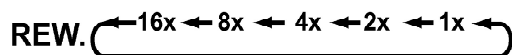

- Press [ **NEXT** ] to advance to the next chapter/track.

Press repeatedly to skip to the next chapter during playback.

- Press [ **PREVIOUS** ] to reverse to the previous chapter.

Press repeatedly to return to the beginning of previous chapters during playback.

- Press [ **PAUSE/STEP** ] to pause playback.

- Press [ **PAUSE/STEP** ] again to start "frame by frame mode."

Press repeatedly to advance DVDs and Video CDs frame by frame during playback in pause mode.

Press [ **PLAY** ] to restart normal playback.

- Press [ **BROWSER** ] to browse the contents of a DVD disc or the HDD.

- Press [ **HDD/DVD** ] to select HDD or ODD to playback the contents saved.

- Press [ **STOP** ] to stop playback at a marked stop.

At a marked stop, press [ **PLAY** ] to resume playback.

Press [ **STOP** ] twice to bring the playback to a full stop.

Press [ **PLAY** ] to start playback from the beginning of the disc.

- Press [ **DISPLAY** ] to display disc status during playback.

- Press [ **DISC MENU** ] to display the thumbnail icons menu on the TV screen.

Press [ **DISC MENU** ] to return to the DVD's title or disc root menu for the current title during playback.

### VCD

### SVCD

Press [ 0, 1~9 ] the numbered buttons to select an item of the title menu.

### DVD

Press [ **▲** ] [ **▼** ] [ **◀** ] [ **▶** ] to select an item and press [ **ENTER** ].

### DVD TITLE

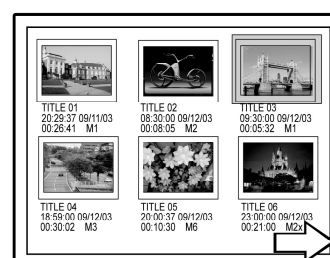

Sample Thumbnail display

- Press [ **PLAYLIST/MENU** ] to display the title menu on the TV screen.

Press [ **▲** ] [ **▼** ] [ **◀** ] [ **▶** ] to select an item and press [ **OK** ].

### Notes:

The [ **PLAYLIST/MENU** ] button only functions while the unit is in playback mode. Depressing this button during other operations won't work on this unit.

- Press [ **CM skip** ] to skip forward 30 seconds during playback.

# PLAYBACK

## Navigation operation

During playback, press [Navi.] to display the "Navigation" menu.



**REPEAT** Repeat playback. Move the highlighted cursor to "REPEAT" and press [OK] repeatedly to choose a repeat option. Depending on the type of Disc, you may choose to play the Track, Title, file or Disc repeatedly.

**Note:**

For DVD, the repeat options are:  
repeat one <-> repeat off

For VCD and SVCD, the repeat options are:  
repeat one <-> repeat all <-> repeat off

For CDDA (audio CD) and data discs, the repeat options are:  
repeat one (except for JPEG files) <-> repeat all <->  
shuffle mode <-> repeat off

**ZOOM** Enables zoom in or out the selected viewing at 1x, 2x, 3x and 4x speed. Press [◀] [▶] [▲] [▼] to move the highlighted cursor to the desired selection on the on-screen panel and press [OK].

**SLOW MOTION** Enables the selection of a slow-motion speed. You can choose to play the Disc at +1/2x, +1/4x or -1/2x, -1/4x.

**SEARCH** Initiates the search capability for locating a desired position in the current title or track (time search). Press the numeric buttons (0 to 9) to enter the desired time or title.

**Example (for DVD-VIDEO)**

To playback from  
**TITLE:CHAPTER : 001/001**  
or **TIME:0 1 : 2 7 : 3 3 (H:M:S)**

**Example (for SVCD/VCD)**

To playback from  
**TIME:0 1 : 2 7 : 3 3**

Press [◀] to correct a mistake.  
Press [◀] repeatedly to move back to the digit where you entered a wrong number, and re-enter the correct one.  
Press [OK] to start playback from the specified time.

**Notes:**

Moving the cursor left through each menu takes you to the previous level. Moving the cursor left at the first menu selection closes the dialog box.

## A-B REPEAT

Repeating a desired part.  
Select "Point A" at the beginning of the part you want to repeat.  
Select "Point B" at the end of the part you want to repeat.  
The unit locates "A" and starts repeat playback between "A" and "B."  
Select [Cancel]. The A-B repeat mode turns off, then normal playback continues.

**SUBTITLE** During playback to select a subtitle language from those available on the current disc.

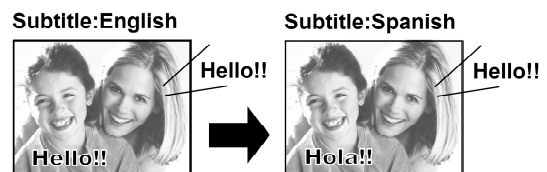

**Notes:**

Some DVDs include subtitles in different languages. If you want to choose subtitles, follow these steps.

## AUDIO

To select a different audio language or soundtrack during DVD playback.



**Notes:**

Multiple languages or soundtracks must be available on the DVD.

## ANGLE

To select a different camera angle during DVD playback.

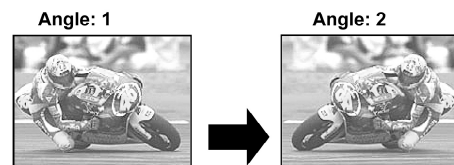

**Notes:**

The Multiple Angles capability must be available on the DVD. (within the current title) or track for playback.

## INFORMATION

To enable or disable the DVD/VCD/SVCD disc information.

## TO EXIT NAVIGATION

Press [Navi.] again or repeatedly press [◀] to exit the "Navi" menu. Or go to "EXIT" and press [OK].

# VIDEO TITLE PLAYBACK (BY BROWSER)

This unit can play video titles recorded on the HDD or the recordable DVD disc.

## Playing back video title

1. Place a disc with recorded video titles on the tray or make sure that the video titles are saved on the HDD.
2. Press the [HDD/DVD] button to select HDD or DVD.
3. Press the [BROWSER] button and this will bring up the browser menu with thumbnails.

If you want to view the text menu, move the cursor to the "Text View" icon and press [OK].

If you want to change the playback device, press [◀▶] to move the highlight to the "HDD" icon or "DVD" icon (depending what the source is set as) and press [OK] to change the setting.

### Note:

The index page numbers shown on the bottom of the browse menu varies with the number of titles/files saved on the HDD/ DVD disc and do not always follow the numeric order. This is designed for easier access to each page when there are more titles/files available.

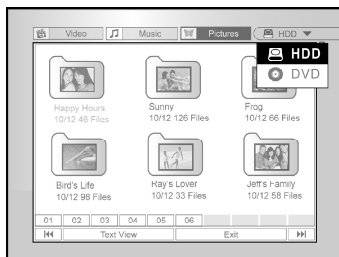

4. Press [◀▶] to move the highlight to the "Video" icon and press [OK] to view the file menu with thumbnails.



If you want to view the text menu, move the highlight to the "Text View" icon and press [OK].

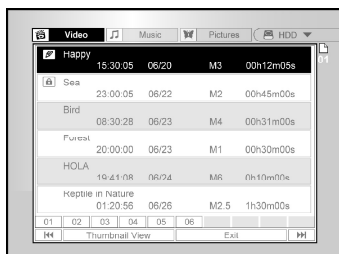

5. Press [▲] [▼] [◀▶] to move the highlight to the file you want to start playback and press [OK].
6. Press [||▶ PAUSE] to pause playback.  
Press [■ STOP] to stop playback at a marked stop.  
Press [■ STOP] twice to bring the playback to a full stop.

# MUSIC FILE PLAYBACK, PICTURE FILE PLAYBACK (BY BROWSER)

The unit can play an Audio CD, JPEG or MP3 files on a disc or from the HDD.

## Playing back music files

### Playing back MP3 files.

1. Place a MP3 disc on the tray or save the MP3 files to the HDD. MP3 files residing on the HDD can be played from the hard disk.

2. Press the [HDD/DVD] button to select HDD or DVD.

3. Press the [BROWSER] button on the list and this will bring up the browser menu with thumbnails.

If you want to change the playback device, press [◀] [▶] [▲] [▼] to move the highlighted cursor to the “HDD” icon or “DVD” icon (depending which source your desire) and press [OK] to change the setting.

4. Press [◀] [▶] to move the highlighted cursor to the “Music” icon and press [OK] to view the file menu with thumbnails.

If you want to view the text menu, move the highlighted cursor to the “Text View” icon and press [OK].

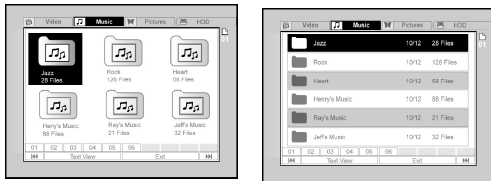

5. Press [▲] [▼] [◀] [▶] to move the highlighted cursor to the file you want to start playback from and press [OK].

6. During playback, press [▶▶] NEXT ] or [◀◀ PREVIOUS] to advance to the next or return to the previous file.

7. Press [||] PAUSE] to pause playback.

8. Press [■ STOP] to stop playback at a marked stop. Press [■ STOP] twice to bring the playback to a full stop.

### Notes:

1. If a MP3 file name includes any 2-byte character, the unit may not display the file name correctly.
2. The unit cannot support ID3 tag.
3. The unit does not support MP3-Pro or WMA files.
4. The unit supports discs recorded with multiple sessions.
5. The unit can only playback picture or tracks with the following file extensions; JPG or jpg, BMP or bmp and MP3 or mp3 etc.
6. The time required for reading disc contents may vary for different discs. This is dependent upon the numbers of groups (folders) and tracks (files) recorded and etc.
7. You cannot advance or reverse playback by pressing F.F. or REW. during JPEG/MP3/BMP disc playback.
8. You cannot play audio track by pressing the numbered buttons during MP3 disc playback.
9. This unit supports MP3 file bitrates of: 32Kbps ~ 320Kbps.

## Playing back picture files

### Playing back JPEG/BMP files.

1. Place a JPEG/BMP disc on the tray or save the JPEG/BMP files to the HDD. JPEG/BMP files residing on the HDD can be played from the hard disk.

2. Press the [HDD/DVD] button to select HDD or DVD.

3. Press the [BROWSER] button on the list and this will bring up the browser menu with thumbnails.

If you want to change the playback device, press [◀] [▶] [▲] [▼] to move the highlighted cursor to the “HDD” icon or “DVD” icon (depending what the source is set as) and press [OK] to change the setting.

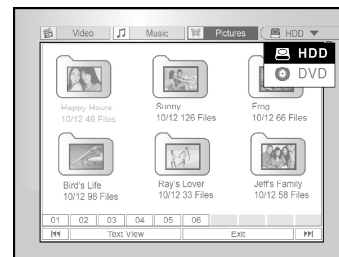

4. Press [◀] [▶] to move the highlighted cursor to the “Pictures” icon and press [OK] to view the file menu with thumbnails.

If you want to view the text menu, move the highlighted cursor to the “Text View” icon and press [OK].

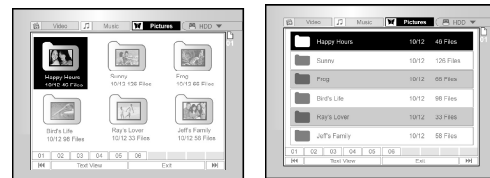

5. Press [▲] [▼] [◀] [▶] to move the highlighted cursor to the file you want to start playback from and press [OK].

6. During playback, press [◀] [▶] to advance to the next or return to the previous file.



7. Press [▲] [▼] to select “Rotate RIGHT” or “Rotate LEFT” and “Rotate UP” or “Rotate DOWN.”

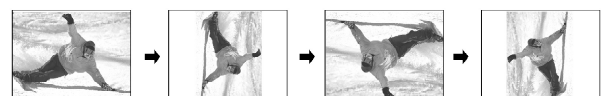

8. Press [||] PAUSE] to pause playback.

9. Press [■ STOP] to stop playback at a marked stop. Press [■ STOP] twice to bring the playback to a full stop.

# AUDIO CD PLAYBACK, PLAYBACK PICTURES AND MUSIC

## Audio CD playback

### Playing Audio CDs

1. Place the Audio CD on the tray.  
The disc will begin playback automatically.
2. Press [▶▶ NEXT] or [◀◀ PREVIOUS] to advance to the next track or return to previous track.
3. Press [⏸ PAUSE] to pause playback.
4. Press [■ STOP] to stop playback at a marked stop.  
Press [■ STOP] twice to bring the playback to a full stop.
5. Enter the numbered button (0~9) to select the desired audio track, and press [OK].  
Begin playing from a selected track.

Playback will start.

8. During playback, press [▶▶ NEXT] or [◀◀ PREVIOUS] to advance to the next or return to the previous music file.
9. Press [◀] [▶] to go to the next or return to the previous JPEG file.  
Press [▲][▼] to select “Rotate RIGHT” or “Rotate LEFT” and “Rotate UP” or “Rotate DOWN.”
10. Press [⏸ PAUSE] to pause the playback.  
Press [■ STOP] to stop playback at a marked stop.  
Press [■ STOP] twice to bring the playback to a full stop.

## Slide show (Pictures with Music)

Concurrent playing of pictures and music files on the same disc.

1. Place the disc with the audio (MP3) and the picture (JPEG/BMP) files on the tray or make sure that the audio and picture files are saved onto the HDD. The saved audio and music files can be played from the hard disk.
2. Press [📖 GUIDE] for the Guide Menu.
3. Press [▲] [▼] to go to the “PLAYBACK” icon and press [OK].
4. Press [▲] [▼] to select HDD or DVD to play the files from and press [OK].

### Note:

Music and picture files can be played concurrently when these files are saved onto the same device.

5. Press [▲] [▼] to go to the “Pictures with music” icon and press [OK].

The browser menu of picture files will be displayed first.

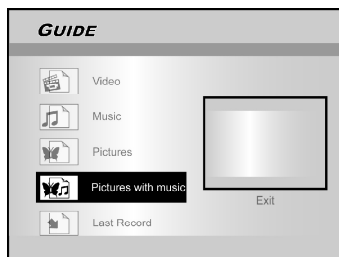

6. Press [▲] [▼][◀] [▶] to select the picture file to start playback with and press [OK].  
The browser menu of audio files will be displayed.
7. Press [▲] [▼][◀] [▶] to select the music file to start playback with and press [OK].

# COPY

This DVD recorder is equipped with "One Touch Copy" feature, which allows you to copy recorded files from the HDD to DVD or from DVD to HDD. This function is only applicable to JPEG, BMP, MP3 files and recorded video titles.

## Copying from DVD to HDD

1. Press [STANDBY-ON] to turn the unit and your TV on.
2. Press [▲ OPEN/CLOSE] to open the disc tray and place the disc with the label side up.
3. Press the [HDD/DVD] button and select "DVD."
4. Press the [BROWSER] button to browse the files.
5. Press [▲] [▼] [◀] [▶] to move the highlight cursor to the file to be copied and press [COPY].

The file is then copied to your HDD.



## Copying from HDD to DVD

1. Press [STANDBY-ON] to turn the unit and your TV on.
2. Press [▲ OPEN/CLOSE] to open the disc tray and place a recordable DVD disc with the label side up. Make sure to insert a recordable DVD disc. Press the button again to close the tray. When you insert a new recordable DVD disc, the DVD recorder automatically starts the disc preparation process.
3. Press the [HDD/DVD] button and select "HDD."
4. Press the [BROWSER] button to browse the files.
5. Press [▲] [▼] [◀] [▶] to move the highlighted cursor to the file to be copied and press [COPY].

The file is then copied to the DVD disc.



### Note:

1. Title name, chapter markers (for video titles), as well as thumbnail picture markers you see in the browser menu are also copied.
2. The chapter markers in the copied version may not be in exact the same positions as the original when recording on a Video mode disc.
3. You can't use the One Touch Copy function to copy a title if any part of the title is copy-once protected.
4. You may use this product only to reproduce or copy materials for which you own the copyright or have which obtained permission to copy from the copyright owner or for you otherwise have a legal right to reproduce or copy. Unless you own the copyright or have obtained permission from the copyright owner or otherwise have a legal right to reproduce or copy, you may be violating the law, including copyright law, and may be subject to payment of damages and other remedies.

## Transfer Speed from HDD

(based on 1 hour recording)

Recording Mode	Transfer Speed	Time
HQ	X 4	~ 18 minutes
SP	X 8	~ 10 minutes
SPP	X 10	~ 8 minutes
LP	X 12	~ 6 minutes
EP	X 16	~ 4 minutes
SLP	X 24	~ 3 minutes



# EDIT

## Before starting to edit

This section explains the basic editing functions on the unit. Please finish all the editing before finalizing the disc. You cannot edit the contents on a finalized disc. You can perform the editing functions on video titles only.

### Browser menu

1. Press [⏻ STANDBY] and press [HDD/DVD] to select the source "DVD" or "HDD" to browse from.
2. Press the [BROWSER] button to display the "BROWSER" menu.
3. Press [◀] [▶] [▲] [▼] to select the title you want to edit, and press [EDIT] to go to the edit screen.

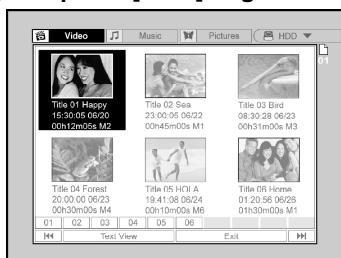

### Naming a title (HDD and DVD)

1. Press [▲] [▼] to select "Rename" and then press [OK].

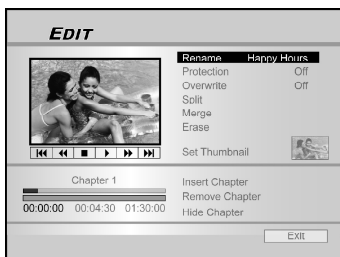

2. The menu for the title naming is displayed.



3. Press [▲] [▼] to select the "Clear" icon and then press [OK] before start entering the new title. Press [◀] [▶] [▲] [▼] to select "Back" to delete characters.
4. Use [◀] [▶] [▲] [▼] and [OK] on the remote control to select desired characters.
5. When you finish entering the title, press [◀] [▶] [▲] [▼] to select "Finish" and press [OK].

#### Notes:

You only can enter up to 30 characters for a name. You can not leave the title column blank.

### Protecting a title (HDD and DVD)

You can protect the title from accidental erasure or editing when you activate the protect function. When protection is turned "ON," the title can't be edited or erased. If you do need to edit it, you must first unlock the file.

1. Press [BROWSER] to display the "Browser" menu.
2. Press [◀] [▶] [▲] [▼] to select the title you want to edit and then press [EDIT] to go to the edit screen.
3. Press [▲] [▼] to select "Protection" and then press [OK].
4. Press [OK] to select the "On" or "Off".



5. Press [▲] [▼] to select "EXIT" and then press [OK].

#### Note:

You can NOT protect the recorded title(s) on a DVD+R disc if the disc is finalized.

### Overwriting a title (DVD only)

1. Press [HDD/DVD] to select the "DVD."
2. Press the [BROWSER] button to display the "Browse" menu.
3. Press [◀] [▶] [▲] [▼] to select the title you want to edit and then press [EDIT] to go to the edit screen.
4. Press [▲] [▼] to go to "Overwrite" and then press [OK] to set it on or off. The "Overwrite" mode is set.

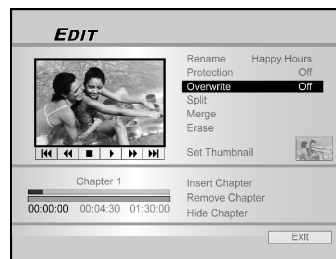

5. Press [▲] [▼] to select "EXIT" and then press [OK].

#### Notes:

The "overwrite" function is not applicable to video titles saved on the HDD or a DVD+R disc that is finalized.



## EDIT

### Splitting a title (HDD and DVD+RW disc)

Use this function to divide a title into two distinct sessions on either a disc or the HDD.

After splitted, the new title can still be merged again.

1. Press [BROWSER] to display the “Browser” menu.
2. Press [◀] [▶] [▲] [▼] to select the title you want to edit and then press [EDIT] to go to the edit screen.
3. Press [▶] [▶] [▶] to start the title playback first. Press [▶] [▶] [▶] NEXT or [◀] [◀] [◀] PREVIOUS to advance to the next chapter or the previous chapter. Press [▶] [▶] [▶] F.F. or [◀] [◀] [◀] REW ] to perform fast forward or fast rewind scanning.

4. Move the highlighted cursor to “split” and press [OK] for confirmation.

The title is splitted into two titles at where you press [OK] during playback.

5. When complete, the browser menu will be displayed.

6. To split more titles, repeat from step 2 to 4. Or press [▲] [▼] to select “EXIT” and then press [OK] to exit the setting.

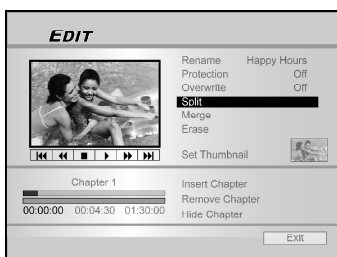

#### Note:

It's not possible to split a video title saved on a DVD+R disc.

### Merging two titles into one (HDD and DVD+RW disc)

Use this function to merge two titles into one.

After merged, the new title can still be splitted again.

1. Press [BROWSER] to display the “Browser” menu.
2. Press [◀] [▶] [▲] [▼] to select the title you want to edit and then press [EDIT] to go to the edit screen.
3. Press [▲] [▼] to select “Merge” and then press [OK].

A menu shows all the titles applicable to this function, which are titles with the same recording quality as the title selected, will display.

4. Press [◀] [▶] [▲] [▼] to select the title to merge and then press [OK].

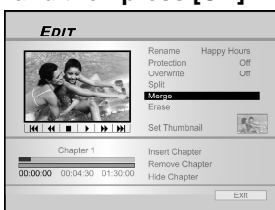

5. To merge more titles, repeat from step 2 to 4. Or press [▲] [▼] to select “EXIT” and then press [OK] to exit the setting.

#### Note:

1. It's not possible to merge a video title saved on a DVD+R disc.
2. For video titles saved on a DVD+RW disc, you can only merge the title with its previous/next title only.

### Erasing a title (HDD and DVD)

Use this function to erase a title.

Note that once erased, the title(s) cannot be retrieved.

1. Press [BROWSER] to display the “Browser” menu.
2. Use [◀] [▶] [▲] [▼] to select the title you want to edit and then press [EDIT] to go to the edit screen.
3. Press [▲] [▼] to select “Erase.”
4. Press [OK] to confirm your setting.

The title selected is erased.



5. To erase more titles, repeat from step 2 to 4. Or press [▲] [▼] to select “EXIT” and then press [OK] to exit the setting.

#### Note:

You can NOT erase recorded title(s) on a DVD+R disc if the disc is finalized.

### Setting a title thumbnail (HDD and DVD)

Normally the first picture of a recording is used as the index picture. However, you can choose any picture from the recording as the index picture.

1. Press [BROWSER] to display the “Browser” menu.
2. Use [◀] [▶] [▲] [▼] to select the title you want to edit and then press [EDIT] to go to the edit screen.
3. Press [▶] [▶] [▶] to start the title playback first. Press [▶] [▶] [▶] NEXT or [◀] [◀] [◀] PREVIOUS to advance to the next chapter or the previous chapter. Press [▶] [▶] [▶] F.F. or [◀] [◀] [◀] REW ] to perform fast forward or fast rewind scanning.

Press repeatedly to play the title forward or reverse.

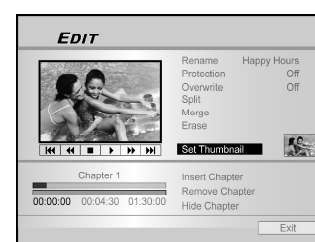

## EDIT

4. Press [▲] [▼] to select “Set Thumbnail.”

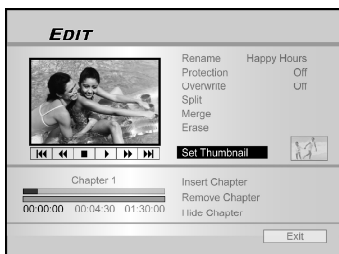

5. Press [OK] to select the image during playback and set it as the video title thumbnail.

6. To set thumbnails for more titles, repeat from step 2 to 5. Or press [▲] [▼] to select “EXIT” and then press [OK] to exit the setting.

### Note:

You can NOT set the thumbnail for the recorded title(s) on a DVD+R disc if the disc is finalized.

## Inserting chapter mark

During playback you can set and erase chapter mark(s) within a title.

1. Press [BROWSER] to display the “Browser” menu.
2. Press [◀] [▶] [▲] [▼] to select the title you want to edit, and then press [EDIT] to go to the edit screen.

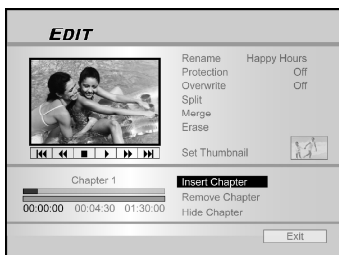

3. Press [▲] [▼] to select “Insert Chapter Mark.”

4. Press [▶] [PLAY] to start the title playback first. Press [▶▶] [NEXT] [◀◀] [PREVIOUS] to advance to the next chapter or the previous chapter. Press [▶▶▶] [F.F.] [◀◀◀] [REW] to perform fast forward or fast rewind scanning.

Press repeatedly to play the title forward or reverse.

5. Press [OK] to insert chapter marks at where you want to during playback.

6. To insert chapter marks in more titles, repeat from step 2 to 5. Or press [▲] [▼] to select “EXIT” and then press [OK] to exit the setting.

### Note:

You can NOT insert chapter marks to recorded title(s) on a DVD+R disc if the disc is finalized.

## Erasing Chapter Mark

During playback you can set and erase chapter mark(s) within a title.

1. Press [BROWSER] to display the “Browser” menu.
2. Press [◀] [▶] [▲] [▼] to select the title you want to edit, and then press [EDIT] to go to the edit screen.



3. Press [▲] [▼] to select “Erase Chapter.”

4. Press [▶] [PLAY] to start the title playback first. Press [▶▶] [NEXT] [◀◀] [PREVIOUS] to advance to the next chapter or the previous chapter. Press [▶▶▶] [F.F.] [◀◀◀] [REW] to perform fast forward or fast rewind scanning.

Press repeatedly to play the title forward or reverse.

5. During playback you can press [OK] to erase the chapter mark.

6. To erase chapter marks in more titles, repeat from step 2 to 5. Or press [▲] [▼] to select “EXIT” and then press [OK] to exit the setting.

### Note:

1. You can NOT erase the chapter marks within recorded title(s) on a DVD+R disc if the disc is finalized.

2. This function is not applicable to files without any chapter marks.

# EDIT

## Hiding Chapter

During playback you can set and hide chapters within a title.

1. Press [BROWSER] to display the “Browser” menu.
2. Press [◀] [▶] [▲] [▼] to select the title you want to edit, and then press [EDIT] to go to the edit screen.



3. Press [▲] [▼] to select “Hide Chapter.”
4. Press [▶] [PLAY] to start the title playback first. Press [▶▶] [NEXT] [◀◀] [PREVIOUS] to advance to the next chapter or the previous chapter. Press [▶▶] [F.F.] [◀◀] [REW ] to perform fast forward or fast rewind scanning. Press repeatedly to play the title forward or reverse.
5. During playback you can press [OK] to hide a chapter.
6. To hide mores chapters, repeat from step 2 to 5. Or press [▲] [▼] to select “EXIT” and then press [OK] to exit the setting.

### Note:

1. You can NOT hide chapters within recorded title(s) on a DVD+R disc if the disc is finalized.
2. This function is not applicable to titles without chapter marks.
3. After performing this function, the chapters within the title are hidden only during playback.
4. In Edit mode, a hidden chapter is displayed in a darker color. A message “hidden” is also displayed at the left bottom corner of the PIP.

# DISK TOOLS

## Erase

Before you begin erasing any contents from a DVD+RW disc or the HDD, please ensure that all important contents are safely backed-up. All contents on the disc or HDD will be permanently erased.

### Note:

Only DVD+RW discs and the HDD can be erased to create a new format.

1. Press [Disk Tools] to display the “Disk Tools Menu.”
2. Press [▲] [▼] to select “Erase” and then press [OK].

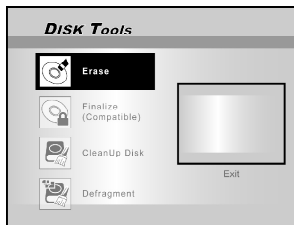

3. Press [▲] [▼] to select “DVD” or “HDD” and press [OK]. Press [OK] to start erasing. The erasing process will take place.

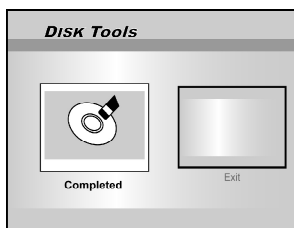
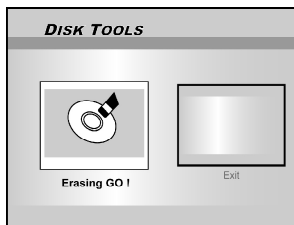

4. When complete, go to “EXIT” and press [OK].

## Finalize (make compatible)

### CAUTIONS:

#### For DVD+R disc:

Finalizing is necessary when you want to play discs recorded with this unit on other DVD players or PCs with a DVD drive. Once the disc has been finalized, you can not add recording(s) to it or edit it.

### Note:

For DVD+RW discs, finalizing is NOT required.

1. Press [Disk Tools] to display the “Disk Tools Menu.”

2. Press [▲] [▼] to select the “Finalize” icon and then press [OK].

The finalization process will take place.

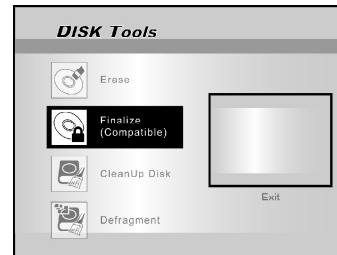

3. When complete, go to “EXIT” and press [OK].

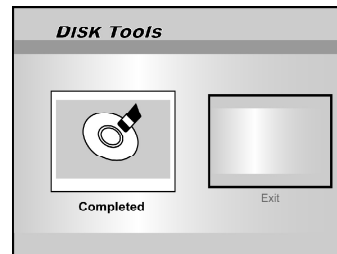

# DISK TOOLS

## CleanUp Disk (HDD only)

1. Press [Disk Tools] to display the “Disk Tools Menu.”
2. Press [▲] [▼] to select the “CleanUp Disk,” and then press [OK].

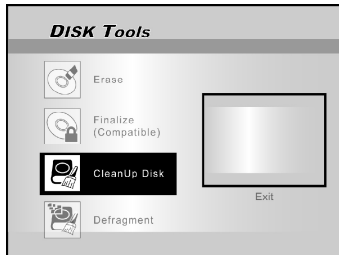

3. Press [▲] [▼] to select the “Delete Older Files,” “Delete Larger Files,” “Delete Seldom Played Files,” “Delete Album” or “Delete All” and then press [OK].

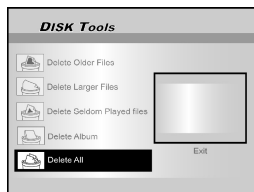
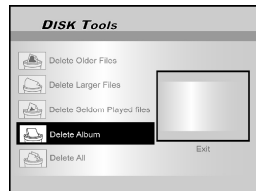
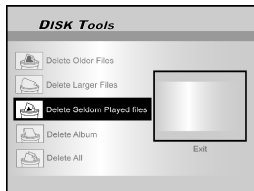
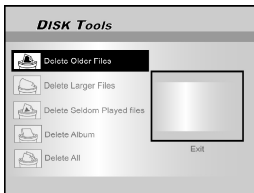

4. The cleanup process will take place.
5. When complete, move the highlighted cursor to “EXIT” and press [OK] to exit.

### Note:

The “Cleanup” operation will permanently delete the files being selected.

## Defragment (HDD only)

The “Defragment” process reorganizes the contents of the HDD creating continuous blocks of available space.

1. Press [Disk Tools] to display the “Disk Tools Menu.”

2. Press [▲] [▼] to select “Defragment” and then press [OK].

The defragment operation begins.

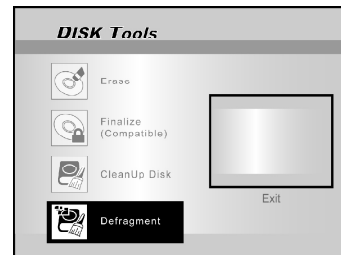

3. When the “Defragment” process is completed, press [▶] and [OK] to exit the “Disk Tools” menu.

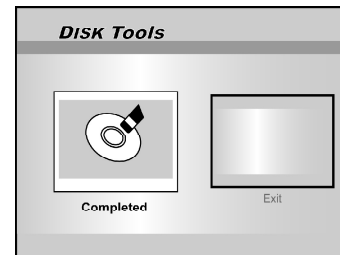

### Note:

1. Contents of the HDD will not be lost during this process.
2. Frequent “defragment” operations are recommended to improve performance.

# GUI OPERATION

## System

### Video Output

Switch video output signal.

- Component (Default)
- Progressive

### Clock Format

Select the clock format to set the system clock.

- M/D/Y-12Hr    D/M/Y-12Hr    Y/M/D-12Hr
- M/D/Y-24Hr    D/M/Y-24Hr    Y/M/D-24Hr

### Date

Set the date of the system clock.

### Time

Set the time of the system clock.

- HH:MM:SS    AM/PM

### Auto-Sleep

- Off/30/60/90/120mins (Default: Off)

### Note:

"Auto sleep" sets how long the DVD recorder is switched to "STANDBY" mode when no operation of the system is detected (e.g. recording, playback, timer record or editing).

### Restore

- (Off)                      Restore

## Audio

### Digital Output

Settings of digital audio output.

- PCM (Enable digital audio output with PCM data)
- Bit Stream (Enable digital audio output with encode data) (Default)

### DTS Output

Enable/Disable Digital Theater System output.

- ON (Enable Digital Theater System mode)
- OFF (Disable Digital Theater System mode)

### TV Audio

- Stereo MAIN    SAP (second audio program)
- Mono

## Language

### OSD

Select a system operating language. The options are :  
English, 繁體中文, Αἰῶνικά, Français,  
Español, Bahasa Malaysia

### Menu Language

Select a menu operating language. The options are :  
English, Traditional Chinese, Simplified Chinese,  
French, Spanish, Malay

### Audio Language

Select a audio operating language. The options are :  
English, Traditional Chinese, Simplified Chinese,  
French, Spanish, Malay

### Subtitle Language

Select a subtitle operating language. The options are :  
English, Traditional Chinese, Simplified Chinese,  
French, Spanish, Malay, Off

## Playback

### Aspect Ratio

Settings of audio and video parameters when playing back.  
16:9 Wide    4:3 Pan    4:3 L.Box (Default)

### Parental

Set content control for supported DVD.  
Set Level (Off , 1-8 )

The parental control levels are:

- 1: Kid Safe                      2: G                              3: PG
- 4: PG-13                        5: PG-R                        6: R
- 7: NC-17                        8: Adult                        Off

### Password

Set a system protect password. Password is needed for the changing the setting.

- OLD Password (XXXX)    NEW Password (XXXX)
- Confirm                      (XXXX)                      \*(Default:0000)

### Slide Time

Set the slide show interval while playing JPEG files.  
Off    3-99 Seconds (Default: 5)

### VCD PBC

Enable/Disable play back control for VCD and SVCD.  
ON (Default)    OFF

# GUI OPERATION

## Record

### Record Quality

Set the default quality of recording.

M1	M2	M2x
M3	M4	M6

### Chapter Mark

Set the interval of chapter auto-insertion while recording.

Off 5/10/15/20/25/30 mins

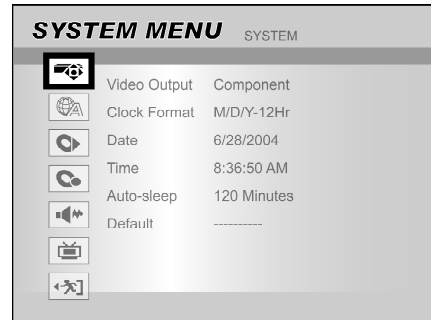

## Recording Mode

Quality	Rec. Time (DVD)	Rec. Time (HDD)
M1	1 Hour	16 Hours
M2	2 Hours	32 Hours
M2x	2.5 Hours	43 Hours
M3	3 Hours	48 Hours
M4	4 Hours	64 Hours
M6	6 Hours	96 Hours

- 1) Press [SYSTEM MENU] to display the system menu.
- 2) Press [▲] [▼] to select “System,” “Language,” “Playback,” “Record,” “Audio,” “TV Tuner” or “EXIT” and press [▶] or press [◀] to return to preview layer.
- 3) Press [▲] [▼] to select the item and press [▶] or [OK].
- 4) Press [▲] [▼] to set the option and press [OK].

### To exit the SYSTEM menu

Press [SYSTEM MENU] or and press [◀] until you return to the main menu.

## TV Tuner

**TV Signal** --> Antenna or Cable or Auto

(Select the type of antenna input)

**Country** --> Select your location

**Utilities** --> scan channel or edit channel

(Select to start rescanning channel or edit a channel)

**Fine Tune** --> -24 ~ -1 0 +1 ~ +24

(Select to fine tune the channel frequency manually)

## GLOSSARY

### **480i/480p**

Indicates the number of scanning lines and scanning format of an image signal.

480i indicates 480 scanning lines with interlace format, and 480p indicates 480 scanning lines with progressive format.

### **Aspect ratio**

Aspect ratio refers to the length to height ratio of TV screens. The ratio of a standard TV is 4:3, while the ratio of a high-definition or wide TV is 16:9. The letter box allows you to enjoy a picture with a wider perspective.

### **Bitstream**

The digital form of multi-channel audio data (e.g., 5.1-channel) before it is decoded into its various channels.

### **Chapter / Title**

Chapter is the smallest division and title is the largest division on a DVD VIDEO. A chapter is a division of a title and similar to a track for Video CD or Audio CD.

### **Component video**

Video signals with three channels of separate information that makes up the picture. There are some types of component video, such as R/G/B and Y/Cb(Pb)/Cr(Pr).

### **Composite video**

A single video signal commonly used in most consumer video products that contains all luminance, color, and synchronization information.

### **Dolby Digital®**

A six-channel system consisting of left, center, right, left rear, right rear and LFE (Low-Frequency Effect channel, for use with a sub-woofer) channels. It requires a Dolby Digital® decoder, either in the player or in an external receiver to regenerate the sound. All processing is done in the digital domain. Not all Dolby Digital discs contain six (5.1) channels of information.

### **DTS® (Digital Theater Systems)**

DTS® stands for Digital Theater Systems. DTS® is a Digital Surround audio encoding format configured with six (5.1) channels, similar to Dolby Digital®. It requires a DTS® decoder, either in the player or in an external receiver to regenerate the sound. All processing is done in the digital domain. Not all DTS discs contain six (5.1) channels of information.

### **DVD-R**

DVD-R is a recordable disc that is the same size as a DVD-Video. Contents can be recorded only once to a DVD-R, and will have the same format as a DVD-Video.

### **DVD-RW**

DVD-RW is a recordable and rewritable disc that is the same size as a DVD-Video. DVD-RW has two different modes: VR mode and Video mode. DVD created in video mode has the same format as a DVD-Video, while discs created in VR (Video Recording) mode allow the contents to be programmed or edited.

### **DVD+R**

DVD+R is a recordable disc that is the same size as a DVD-Video. Contents can be recorded only once to a DVD+R, and will have the same format as a DVD-Video.

### **DVD+RW**

DVD+RW is a recordable and rewritable disc. DVD+RW use a recording format that is comparable to a DVD-Video format.

### **Interlace output**

NTSC, the video signal standard, has 480 interlaced (I) scan lines. The Interlaced scanning system places lines of the second half of the picture in-between lines of the first half of the picture.

### **JPEG**

A popular file format for still image compression and storage. JPEG stands for "Joint Photographic Experts Group". There are two sub-types of the JPEG format as follows.

- Baseline JPEG: used for digital cameras, the web, etc.
- Lossless JPEG: an old type, rarely used now.

### **Linear PCM audio**

PCM stands for "Pulse Code Modulation". Linear PCM is the usual method for digitally encoding audio without compression, and is used for the audio tracks on DVD VIDEO discs, Audio CDs, etc.

### **MP3**

MP3 (MPEG1 audio layer 3) is a compressed audio file format. Files are recognized by their file extension ".mp3" or ".MP3".

### **MPEG**

MPEG stands for "Motion Picture Experts Group". This is an international standard for compression of moving images. On some DVDs, digital audio has been compressed and recorded in this format.

### **NTSC (National Television System Committee)**

The initials stand for National Television Standards Committee. This is the committee that established the standards for television systems in the United States. The NTSC standard broadcasts 525 or 480 lines of resolution per second, and 30 frames per second of refresh rate, 60 Hz field frequency. NTSC TV system is widely used in USA, Canada, Latin America and Taiwan etc.

### **PAL (Phase Alternation by Line)**

PAL (Phase Alteration Line) is the color television broadcast standard throughout the Western Europe (except in France, where SECAM is the standard), Australia, China, Singapore and Malaysia etc. It has 625 lines of vertical resolution per second and 25 frames per second refresh rate, 50 Hz field frequency.

### **PBC**

Playback Control. A special feature on a Video CD or Super VCD that enables interactive use.

### **S-Video**

A video signal which improves picture quality over standard composite connections. Used on Super VHS, DVD, high end TV monitors, etc.

### **Track**

SVCD, VCD, Audio CD discs use tracks to divide up the content of a disc.



# SPECIFICATIONS

## DISC TYPES SUPPORTED (Read Only):

DVD-R/RW, DVD+R/RW, CD-R/RW

## CONTENT FORMAT SUPPORTED :

- 1) DVD-Video
- 2) DVD+VR (DVD+VR format is compatible with DVD-Video in most case)
- 3) Video CD
- 4) Super VCD
- 5) Audio CD
- 6) MP3  
Maximum number of files recognizable : 9999 files  
Compression rate : between 32 kbps and 320 kbps
- 7) JPEG  
Maximum number of pictures recognizable : 9999 files
- 8) BMP  
Maximum number of pictures recognizable : 9999 files

## RECORDABLE MEDIA SUPPORTED:

- 1) DVD+R (DVD+VR Mode)
- 2) DVD+RW (DVD+VR Mode)
- 3) Built-in 80GB HDD (DVD+VR mode)

## VIDEO RECORDING MODE

Mode	DVD	HDD
M1	1hr	16hr
M2	2hrs	32hr
M2x	2.5hrs	43hr
M3	3hrs	48hr
M4	4hrs	64hr
M6	6hrs	96hr

## VIDEO RECORDING FORMAT

MPEG2: DVD+VR (M1/M2/M2x/M3/M4 mode)

MPEG1: DVD+VR (M6 mode)

## VIDEO PERFORMANCE

### VIDEO PERFORMANCE

DA Converter	10-bit / 54MHz
Composite Output	1 Vpp 75 Ohm
S-Video Output	Y : 1 Vpp 75 Ohm C : 0.3 Vpp 75 Ohm
Components Output	Y : 1 Vpp 75 Ohm P <sub>b</sub> : 0.7 Vpp 75 Ohm P <sub>r</sub> : 0.7 Vpp 75 Ohm

## AUDIO RECORDING FORMAT

DVD+VR (M1/M2/M2x/M3/M4/M6 mode): Dolby Digital 2-channel

## AUDIO FORMAT Supported - Playback

Analog output	2channel
Digital output	coaxial/optical
Format supported	LPCM/Dolby Digital/MPEG

## AUDIO PERFORMANCE

DA Converter	24-bit/96KHZ
AD Converter	24-bit/96KHZ
Signal-Noise (1kHz)	≥90dB
Dynamic Range (1kHz)	≥80dB
Channel Separation (1kHz)	≥110dB
Total Harmonic Distortion (1kHz)	≤-65dB

## TUNER

TV format	PAL
-----------	-----

## CONNECTIONS

### FRONT PANEL

Video Input	RCA Connector (yellow) x1
Audio L/R Input	RCA Connector (white/red) x1
IEEE 1394 Input	Mini jack x1

### REAR PANEL

Video Output	RCA Connector (yellow) x1
Audio L/R Output	RCA Connector (white/red) x1
S-Video Output	4-pin
Video Input	RCA Connector (yellow) x1
Audio L/R Input	RCA Connector (white/red) x1
S-Video output	4 pin
Component / Progressive Scan Output	Y, P <sub>b</sub> , P <sub>r</sub> (Green/Blue/Red) x1
Digital Audio Output	Coaxial x1 Optical x1

## GENERAL

Power Supply	AC 100 ~ 240V	50/60Hz
Power Consumption	Approx. 50 W	
Operating Temperature	+5°C to +40°C (+36°F to +104°F)	
Operating Humidity	5% to 80% RH	
Dimensions(W/H/D):	430 x 66 x 316 mm	
Net Weight:	Approx. 4.3 kg	

## Notes:

The specifications and design of this product are subject to change without notice.

